

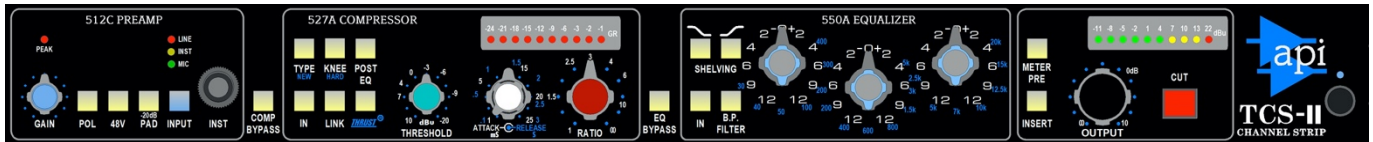

Automated Processes, Inc.

# TCS-II



## The Channel Strip-II

512C – 527A - 550A – 325

# Operator's Manual

Written for Automated Processes, Incorporated  
by Dan Pfeifer  
Rev. 23-03-19

# Table of Contents

<b>About This Manual .....</b>	<b>0</b>
<b>Important Safety Instructions .....</b>	<b>1</b>
<b>1.0 Introduction .....</b>	<b>2</b>
<b>1.1 TCS-II Overview .....</b>	<b>2</b>
<b>2.0 Signal Flow and Block Diagrams .....</b>	<b>3</b>
<b>2.1 Default Signal Flow .....</b>	<b>3</b>
<b>2.2 Alternate Signal Flows .....</b>	<b>3</b>
2.2.1 Compressor Post Equalizer Signal Flow .....	3
2.2.2 Compressor Bypass.....	4
2.2.3 Equalizer Bypass.....	4
2.2.4 Insert.....	5
<b>2.3 512C Preamp Signal Flow.....</b>	<b>5</b>
<b>2.4 325 Output Section Signal Flow.....</b>	<b>6</b>
<b>2.5 Rear Panel Signal Flow .....</b>	<b>6</b>
<b>3.0 Input Section: 512C Preamplifier.....</b>	<b>8</b>
<b>3.1 512C Preamp Overview and Features .....</b>	<b>8</b>
<b>3.2 512C Preamp Controls .....</b>	<b>8</b>
<b>3.3 512C Input Selection .....</b>	<b>9</b>
3.3.1 Input Switch.....	9
3.3.2 Microphone Input.....	9
3.3.3 Instrument Input .....	10
3.3.4 Line Input .....	10
<b>3.4 512C Polarity Inverter .....</b>	<b>10</b>
<b>3.5 512C Level Indication .....</b>	<b>11</b>
3.5.1 Level Meter .....	11
3.5.2 Peak Indicator .....	11
<b>3.6 512C Preamp Output.....</b>	<b>11</b>
<b>3.7 512C Preamp Block Diagram .....</b>	<b>11</b>
<b>4.0 Dynamic Processing: 527A Compressor .....</b>	<b>12</b>
<b>4.1 527A Compressor Overview and Features .....</b>	<b>12</b>
<b>4.2 527A Compressor Controls.....</b>	<b>13</b>
4.2.1 Threshold.....	13
4.2.2 Attack and Release.....	13
4.2.3 Ratio .....	14
4.2.4 Compression Type.....	14
4.2.5 Compression Knee .....	15
4.2.6 <b>THRUST</b> ® .....	16
4.2.7 Gain Reduction Meter .....	16
<b>4.3 527A Compressor Routing.....</b>	<b>17</b>
4.3.1 Compressor Pre Equalizer (Default Signal Flow) .....	17
4.3.2 Compressor Post Equalizer .....	17
4.3.3 Compressor Bypass.....	17

4.3.4 Compressor IN Switch .....	18
<b>4.4 527A Compressor Side Chain.....</b>	<b>18</b>
<b>4.5 527A DC Link.....</b>	<b>18</b>
<b>5.0 Spectral Processing: 550A Equalizer.....</b>	<b>19</b>
<b>5.1 550A Equalizer Overview and Features.....</b>	<b>19</b>
<b>5.2 550A Equalizer Controls.....</b>	<b>20</b>
5.2.1 Low Frequency Band .....	20
5.2.2 Mid Frequency Band .....	21
5.2.3 High Frequency Band .....	21
5.2.4 Band-Pass Filter.....	21
<b>5.3 550A Equalizer Routing.....</b>	<b>21</b>
5.3.1 Equalizer Post Compressor Pre (Default Signal Flow) .....	21
5.3.2 Equalizer Pre Compressor .....	22
5.3.3 Equalizer Bypass.....	22
5.3.4 Equalizer IN Switch .....	22
<b>6.0 Output Section: 325 Line-Driver .....</b>	<b>23</b>
<b>6.1 325 Output Section Overview and Controls.....</b>	<b>23</b>
6.1.1 Output.....	24
6.1.2 Soft Mute.....	24
6.1.3 Insert.....	24
6.1.4 Level Meter .....	24
<b>6.2 325 Output Section Routing .....</b>	<b>25</b>
<b>6.3 325 Output Section Block Diagram .....</b>	<b>25</b>
<b>7.0 Rear Panel Interface.....</b>	<b>26</b>
<b>7.1 Audio Path Inputs.....</b>	<b>26</b>
<b>7.2 Audio Path Outputs.....</b>	<b>27</b>
<b>7.3 Audio Path Half-Normals.....</b>	<b>28</b>
<b>7.4 527A Compressor Side Chain &amp; DC Link Connections .....</b>	<b>29</b>
7.4.1 Side Chain Input.....	29
7.4.2 DC Link .....	29
<b>7.5 Rear Panel Signal Flow .....</b>	<b>29</b>
<b>8.0 AC Power .....</b>	<b>30</b>
<b>APPENDIX.....</b>	<b>31</b>
<b>A1 TCS-II Technical Specifications.....</b>	<b>32</b>
<b>A2 Block Diagrams .....</b>	<b>34</b>
A2.1 Default Signal Flow .....	34
A2.2 Post EQ Signal Flow .....	34
A2.3 512C Signal Flow .....	35
A2.4 325 Output Section Signal Flow .....	35
<b>A3 TCS-II Setup Sheet.....</b>	<b>36</b>
<b>A4 API Limited Warranty and Service.....</b>	<b>37</b>

# About This Manual

This manual explains the operation and applications of the API TCS-II (The Channel Strip II) signal processor. Incorporating four legendary API signal processors into a stand-alone configuration, the TCS-II provides a flexible, high-quality audio signal chain for most production applications.

## Legend:

- **UPPER-CASE BOLD = SWITCHES, BUTTONS, and POTS**
- UPPER-CASE = REAR PANEL CONNECTIONS

## Manual Revision History: YY-MM-DD format

Original: 11-02-22

Revised: 16-02-01

Revised: 23-03-19 TCS-II update with 527A and other features

**Dan Pfeifer is a Professor of Recording Industry  
at Middle Tennessee State University**

# Important Safety Instructions

1. Please read these instructions
2. Keep this information in a safe place
3. Do not use this device near water
4. Clean only with a dry cloth
5. Do not block any ventilation openings
6. Do not install near any heat sources such as radiators, heat registers, stoves, or other devices that produce heat
7. Do not defeat the safety purpose of the polarized or grounding type AC plug
8. Protect the AC power cord from being walked on or pinched
9. Use only attachments/accessories specified by the manufacturer
10. Unplug this device during lightning storms or when unused for long periods of time
11. Refer all service to qualified personnel

**ATTENTION: Exposure to extremely high noise levels may cause permanent hearing loss or damage. Individuals vary considerably in susceptibility to noise-induced hearing loss, but nearly everyone will lose some hearing if exposed to sufficiently intense noise (this may include music) for a period of time. Be safe.**

**WARNING – To reduce the risk of fire or electric shock, do not expose this apparatus to rain or moisture.**

# 1.0 Introduction

The API TCS-II (The Channel Strip II) is a complete input module with a 512C Preamplifier, 527A Compressor, 550A precision EQ, and 325 output level section. With extensive signal metering, multiple balanced insert points and an output mute switch, the TCS-II contains the best features of a large console input channel in a single rack space. It's the perfect choice for anyone looking for that high-performance API console sound.

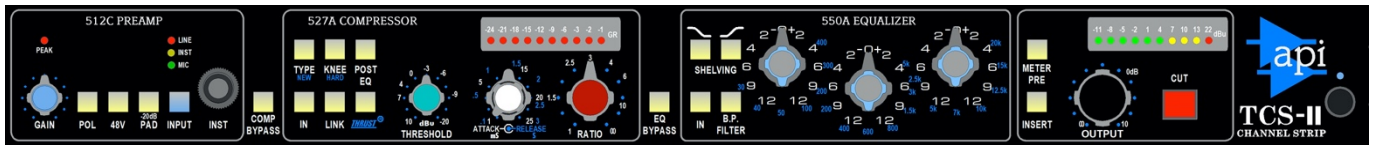

## 1.1 TCS-II Overview

### Features:

- API 512C Preamplifier
- API 527A Compressor
- API 550A Equalizer
- API 325 Line-Driver (output section)
- Internal routing supports multiple configurations
- Comprehensive rear panel interface with multiple insert points
- 10-segment LED gain reduction meter
- 10-segment LED level meter displays preamp and output levels
- Output clips at +30dBu
- Transformer outputs

The result of thoughtful engineering, the TCS-II includes everything needed to record an audio signal. It all starts with the famed 512C Preamplifier, which includes the benefit of additional Mic, Line or Instrument input switching. Next is the 527A multi-mode compressor with fully adjustable Threshold, Attack, Release, and Ratio controls on detented pots. The patented **THRUST**® circuit in the 527A Compressor gives your track the "in-your-face" punch that has made this circuit an award winner. Also included in the TCS-II is probably the most recognized and revered API EQ of all time, the 550A three-band equalizer with its switchable frequencies and 12dB of boost or cut. The 550A Equalizer's High and Low frequency bands can be individually switched to be shelving EQs, and the "B.P. Filter" switch inserts a 50Hz to 15kHz Band-Pass filter. At the output of the unit is the 325 Line-Driver, taken directly from API console designs with an output level pot and 10-segment level meter. The meter can also be switched to show the output level of the preamp. Each of the TCS-II's processing pieces can be switched in or bypassed individually and the 527A can be routed to be post EQ. Additional features include a side-chain input and the famous API 2520/transformer combination.

# 2.0 Signal Flow and Block Diagrams

## 2.1 Default Signal Flow

With no routing switches engaged, the default signal flow through the TCS-II is illustrated by the left-to-right order of the unit's front panel:

**512C Preamp -----> 527A Compressor -----> 550A Equalizer--> Insert --> 325 Output**

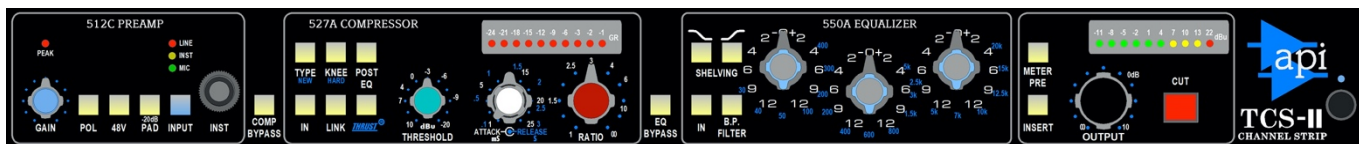

The block diagram below illustrates the TCS-II signal flow with no switches engaged except the **CUT** button. This is the "default" signal flow through the unit.

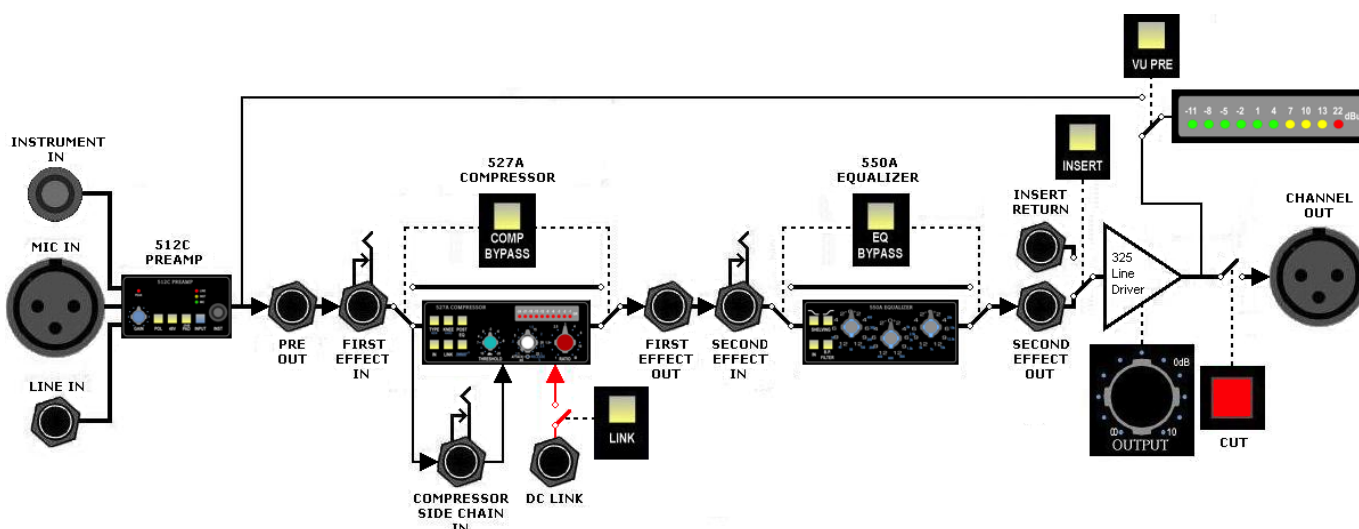

## 2.2 Alternate Signal Flows

The default signal flow can be modified in four (4) ways without patching:

- The 527A Compressor can be moved after the 550A Equalizer (**POST EQ**)
- The 527A Compressor can be hard bypassed (**COMP BYPASS**)
- The 550A Equalizer can be hard bypassed (**EQ BYPASS**)
- Insert Return can be engaged (**INSERT**)

Since each of these routing functions are independent of each other, multiple signal flow configurations are possible. Combined with the open interfacing available on the rear panel, comprehensive and flexible routing possibilities are available to meet most production needs.

### 2.2.1 Compressor Post Equalizer Signal Flow

Engaging the **POST EQ** switch will move the 527A Compressor to after the 550A Equalizer. When the **POST EQ** switch is engaged, the signal flow will be as follows:

**512C Preamp ---> 550A Equalizer ---> 527A Compressor ---> Insert ---> 325 Output**



**POST EQ:** Moves the 527A Compressor to after the 550A Equalizer

- 527A will use Second Effect rear panel interface jacks
- Illuminates when engaged

The block diagram below illustrates the TCS-II signal flow with the **POST EQ** switch engaged. No other switches are engaged except the CUT button.

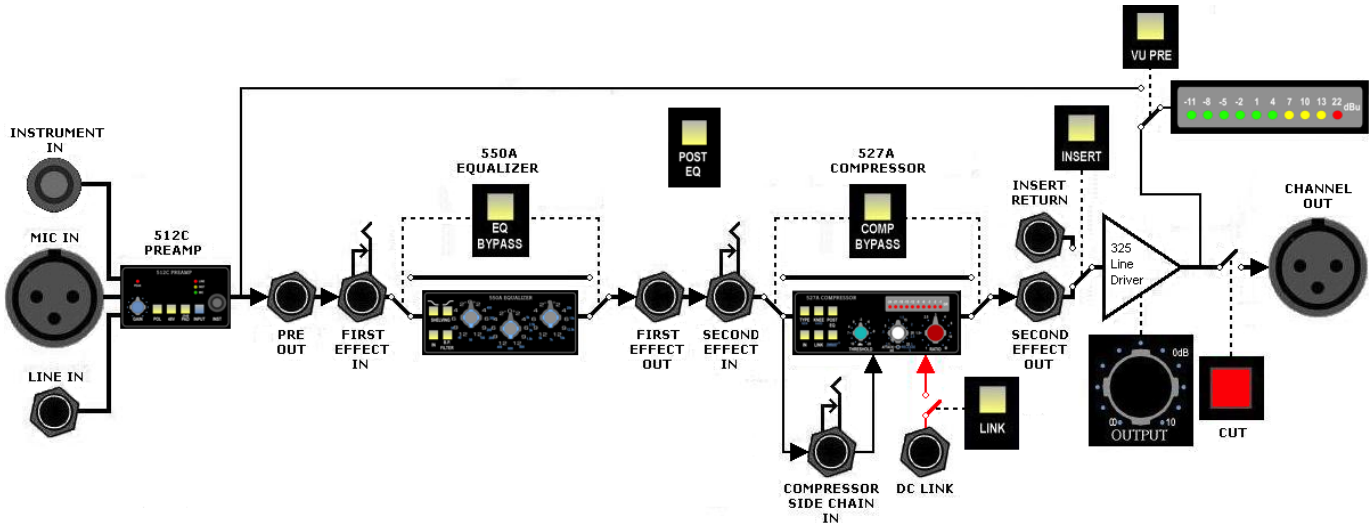

*NOTE: The order of the First and Second Effect jacks on the rear panel does not change with the compressor when the POST EQ switch is engaged.*

### 2.2.2 Compressor Bypass

Engaging the **COMP BYPASS** switch will completely remove the 527A Compressor from the signal path using a relay-based hard bypass. The 527A Compressor will be bypassed regardless of its assigned position in the signal flow. When the **COMP BYPASS** switch is engaged, the signal flow will be as follows:

**512C Preamp ---> 550A Equalizer ---> Insert ---> 325 Output**



**COMP BYPASS:** Removes the 527A Compressor from the signal flow

- 527A will not be accessible via rear panel interface jacks
- Illuminates when engaged

*IMPORTANT NOTE: The 527A Compressor has an "IN" switch that must be engaged in order for the compressor to effect the signal when the **COMP BYPASS** switch is not engaged.*

### 2.2.3 Equalizer Bypass

Engaging the **EQ BYPASS** switch will completely remove the 550A Equalizer from the signal path using a relay-based hard bypass. When the **EQ BYPASS** switch is engaged, the signal flow will be as follows:

**512C Preamp ---> 527A Compressor ---> Insert ---> 325 Output**





**EQ BYPASS:** Removes the 550A Equalizer from the signal flow

- 550A Equalizer will not be accessible via rear panel interface jacks
- Illuminates when engaged

*IMPORTANT NOTE: The 550A Equalizer has an "IN" switch that must be engaged in order for the equalizer to effect the signal when the **EQ BYPASS** switch is not engaged.*

### 2.2.4 Insert

Engaging the **INSERT** switch will route the signal present at the INSERT RETURN jack to the input of the 325 Line-Driver. When the **INSERT** switch is engaged, the signal flow will be as follows:

**Insert ---> Output**



**INSERT:** Routes the signal present at the INSERT RETURN jack to the 325 Line-Driver input

- Replaces the SECOND EFFECT OUT as the input to the 325 Line-Driver
- Illuminates when engaged

*NOTE: Since the signal can be externalized at multiple points in the audio path, the TCS-II does not have a dedicated "insert send" output. PRE OUT, FIRST EFFECT OUT, and SECOND EFFECT OUT are intended to be used as "insert sends" as needed.*

## 2.3 512C Preamp Signal Flow

The block diagram below illustrates signal flow through the 512C Preamp section of the TCS-II with no switches engaged.

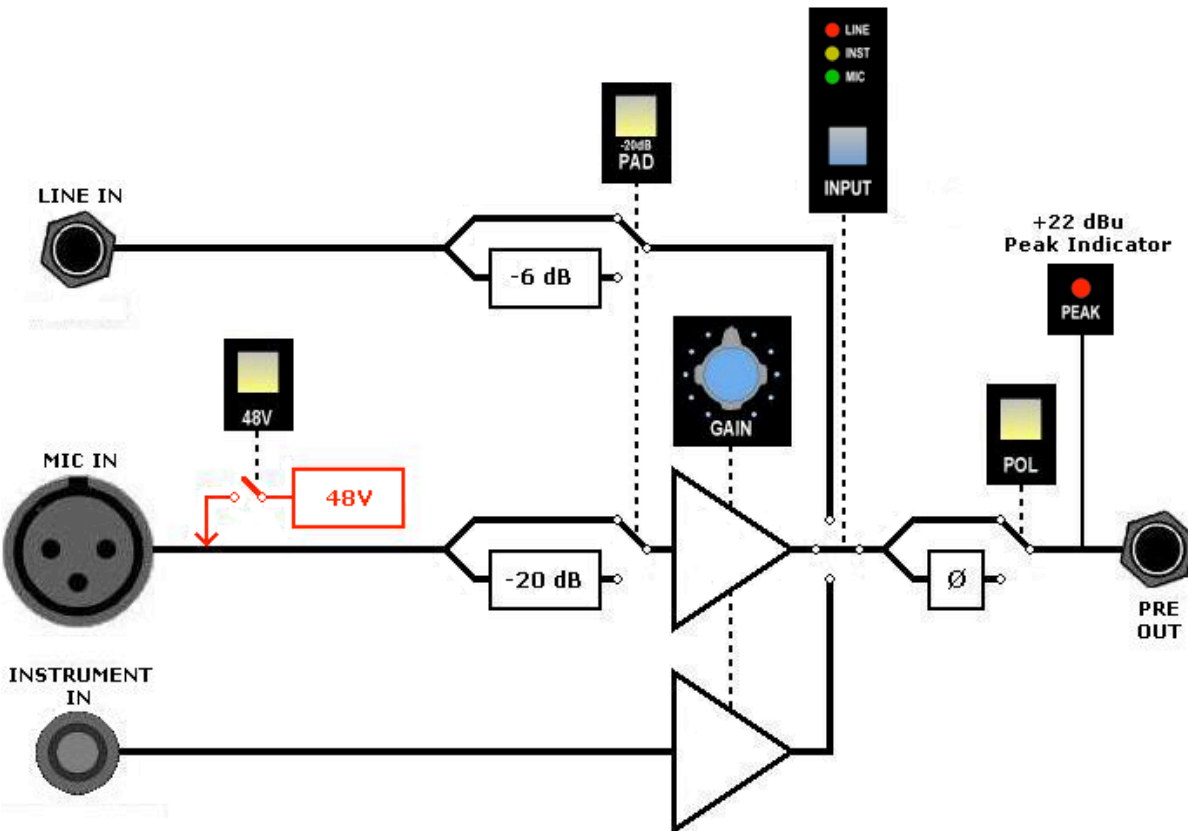

## 2.4 325 Output Section Signal Flow

The block diagram below illustrates signal flow through the 325 Line-Driver output section of the TCS-II with only the **CUT** switch engaged.

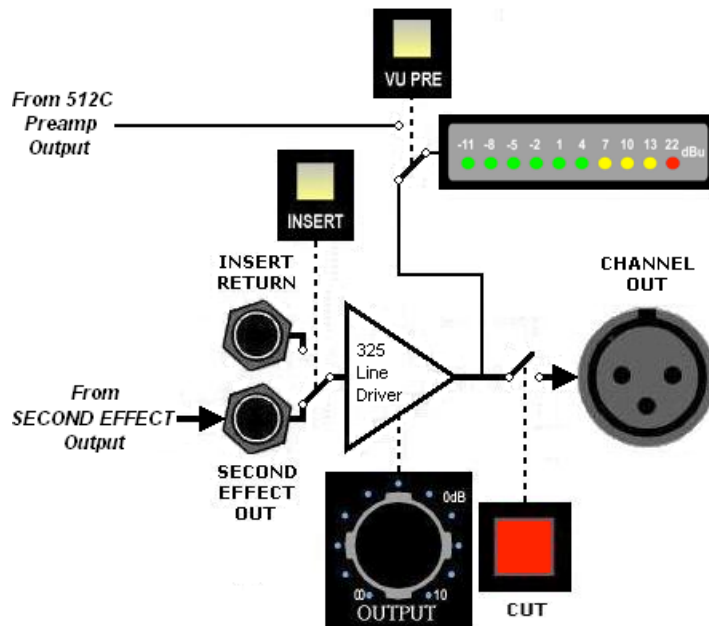

## 2.5 Rear Panel Signal Flow

The TCS-II signal flow is illustrated by the right-to-left order of the unit's rear panel. The order of these interfaces remains constant, regardless of the order of the 527A Compressor and 550A Equalizer in the signal path.

**Output** <----- **Insert** <----- **Second Effect** <----- **First Effect** <----- **512C Preamp**

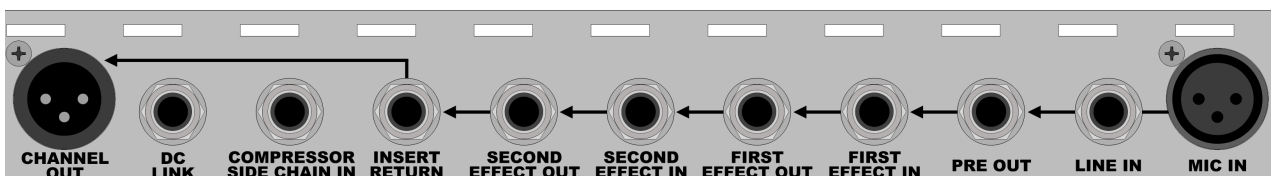

- The PRE OUT is "half-normalled" to feed the FIRST EFFECT IN
- The FIRST EFFECT IN feeds the first processor in the audio path (normally the 527A Compressor\*)
- The FIRST EFFECT OUT is "half-normalled" to feed the SECOND EFFECT IN
- The SECOND EFFECT IN feeds the second processor in the audio path (normally the 550A Equalizer\*)
- The SECOND EFFECT OUT is "half-normalled" to feed the 325 Line-Driver input

\* Engaging the **POST EQ** switch will move the 527A Compressor to after the 550A Equalizer, reversing the order of these effects in the audio path.

The PRE OUT, FIRST EFFECT OUT, and SECOND EFFECT OUT jacks are all splitting outputs. This means the connection to the input they're normalled to will not be broken when a plug is inserted.

The FIRST EFFECT IN and SECOND EFFECT IN jacks are all switching jacks, so connection with the output they're normalled to is broken when a plug is inserted. The input is instead fed with the signal present on the inserted plug.

The INSERT RETURN is only active when the **INSERT** switch on the front panel is engaged.

## 3.0 Input Section: 512C Preamplifier

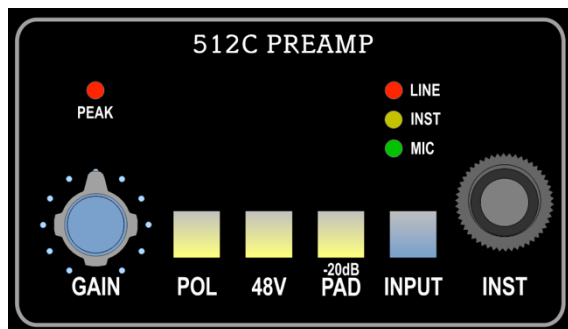

The input section is equipped with the legendary API 512C Preamplifier with microphone, instrument, and line inputs. The 512C Preamplifier is designed to provide an unusually good sounding front-end for all types of audio recording applications. Sonically, it offers the distinct API sound, high quality performance, and low noise.

The 512C Preamp remains faithful to the circuit designs of API's founder, Saul Walker. Fully featured, it carefully preserves the original sound character that made it so much a part of the early days of recording.

### 3.1 512C Preamp Overview and Features

Offering high headroom and a wide variety of inputs and input access points, it is equally at home in the commercial recording studio as it is in the home project studio. The 512C Preamp makes use of the 2520 op-amp and therefore exhibits the reliability, long life, and uniformity which are characteristic of all API products.

#### Features:

- Microphone preamp with 14dB to 68dB total gain range (with -20dB pad)
- Instrument preamp with 14dB to 50dB total gain range
- Line preamp at unity gain
- -20dB microphone pad
- -6dB line pad
- Switchable 48V phantom power
- Polarity inverter
- +22dBu preamp output peak indicator
- Routable to the 10-segment LED level meter
- XLR rear panel balanced, low-impedance MIC input
- 1/4" -10dBu front panel unbalanced, high-impedance instrument (INST) input
- 1/4" TRS +4dBu rear panel balanced, low-impedance LINE IN
- 1/4" TRS +4dBu rear panel balanced, low-impedance line Preamp OUT
- Low noise (-129dBm EIN)
- Famous API 2520 op-amp and transformer

### 3.2 512C Preamp Controls

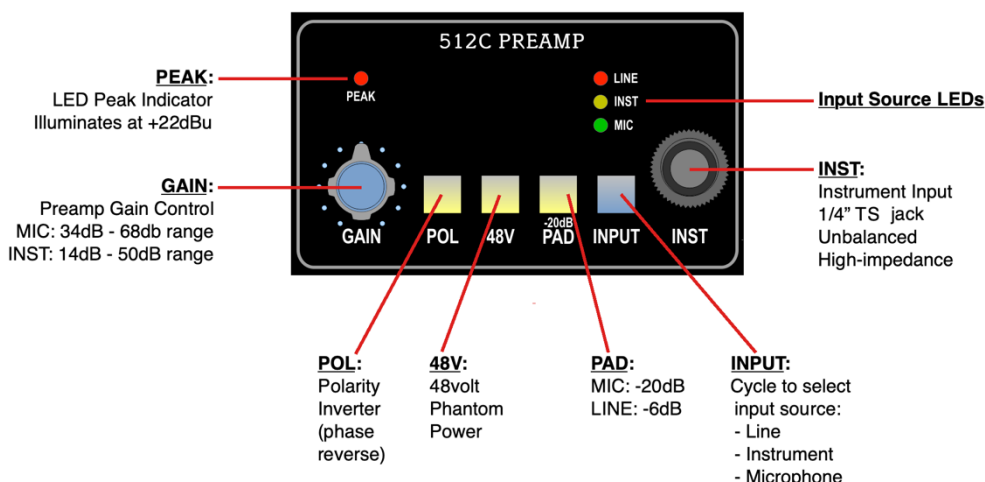

The 512C Preamp provides a comprehensive suite of controls:

- **GAIN**: Microphone and instrument preamp gain
- **POL**: Preamp output polarity inverter
- **48V**: Phantom Power
- **PAD**: -20dB microphone pad / -6dB line pad
- **INPUT**: Mic-Line-Instrument input selector
- **INST**: ¼" unbalanced, high-impedance instrument input
- **PEAK**: +22dBu output peak indicator
- **Input Source LEDs**: Illuminated LED indicates the selected source

## 3.3 512C Input Selection

The 512C Preamp can receive three (3) input sources:

- **MIC (Microphone)**: Rear panel XLR microphone input with switchable 48V phantom power
- **INST (Instrument)**: Front panel ¼" jack, unbalanced, Hi-Z instrument-level input
- **LINE**: Rear panel ¼" TRS balanced, low-impedance, +4dBu line-level input

### 3.3.1 Input Switch



The **INPUT** switch is used to select the active input source. Only one source can be active at a time. The **INPUT** switch is a momentary selector which cycles through the three input sources, LINE-INST-MIC. The input source LEDs indicate the active source:

- **LINE**: Red LED
- **INST (Instrument)**: Yellow LED
- **MIC (Microphone)**: Green LED

### 3.3.2 Microphone Input

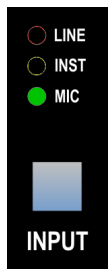

Select the microphone input (MIC) by pressing the **INPUT** button until the red **MIC** LED illuminates. The MIC IN connector on the rear panel will be the active input:



- Female, 3-pin XLR microphone input
- Balanced, low-impedance
- 48v phantom power
- 34dB to 68dB of gain
- -20dB pad
- Green **MIC** LED illuminates when active



**48V**: Provides 48 volt phantom power to the MIC IN female XLR connector

- Illuminates when engaged

**IMPORTANT: Caution should be exercised when engaging phantom power! Damage can occur if phantom power is applied to some audio devices, including most ribbon microphones. The TCS-II output should also be muted (CUT) when engaging the 48V switch.**



**-20dB PAD**: Inserts a -20dB attenuator after the MIC input

- Illuminates when engaged



**GAIN:** Microphone preamp level control

- 34dB nominal gain
- 68dB maximum gain
- 14dB minimum gain with **-20dB PAD** engaged
- 14dB to 68dB total gain range with pad

### 3.3.3 Instrument Input

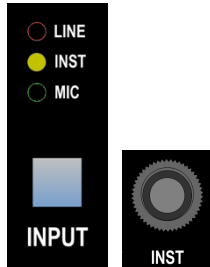

Select the instrument input (INST) by pressing the **INPUT** button until the yellow **INST** LED illuminates. The 1/4" INST jack on the front panel will be the active input:

- -10dBu instrument-level input
- Unbalanced, high-impedance input (1/4" tip-sleeve)
- 14dB to 50dB of gain
- Yellow **INST** LED illuminates when active



**GAIN:** Instrument preamp level control

- 14dB nominal gain
- 50dB maximum gain
- No pad

### 3.3.4 Line Input

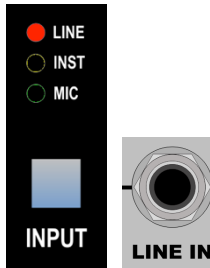

Select the line input (LINE) by pressing the **INPUT** button until the red **LINE** LED illuminates. The 1/4" LINE IN jack on the rear panel will be the active input:

- +4dBu line-level input
- Balanced, low-impedance input (1/4" tip-ring-sleeve)
- -6dB pad
- Unity gain (no preamp gain)
- Red **LINE** LED illuminates when active
- Red peak indication when output exceeds +22dBu



**-20dB PAD:** Inserts a -6dB attenuator after the LINE input

- Illuminates when engaged

## 3.4 512C Polarity Inverter

A polarity inverter (sometimes referred to as a "phase reverse") is available at the output of the 512C Preamp.



**POL (Polarity):** Inverts the polarity of the signal at the output of the preamp

- Illuminates when engaged

## 3.5 512C Level Indication

The output level of the 512C Preamp can be monitored in two (2) ways:

- Level Meter: The level meter in the output section can display the preamp output level
- Peak Indicator: The LED peak indicator will illuminate when the 512C output exceeds +22dBu

### 3.5.1 Level Meter



The output of the 512C Preamp will be displayed on the level meter in the output section when the **VU PRE** switch is engaged.



**VU PRE (VU Preamp):** Routes the output of the 512C Preamp to the level meter input

- Illuminates when engaged

### 3.5.2 Peak Indicator



The 512C Preamp is equipped with a red LED peak indicator. When the output level of the 512C exceeds +22dBu, the **PEAK** LED illuminates.

## 3.6 512C Preamp Output

The output of the 512C Preamp is available at the PRE OUT jack on the rear panel. This jack is "half-normalled" to the FIRST EFFECT IN jack on the rear panel.

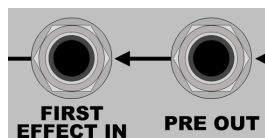

**PRE OUT:** Direct output of the 512C Preamp

- Balanced, low-impedance, +4dBu line-level output
- 1/4" tip-ring-sleeve jack
- Plugging into the PRE OUT jack does not break the connection to the FIRST EFFECT IN jack

## 3.7 512C Preamp Block Diagram

The block diagram below illustrates signal flow through the 512C Preamp section of the TCS-II with no switches engaged.

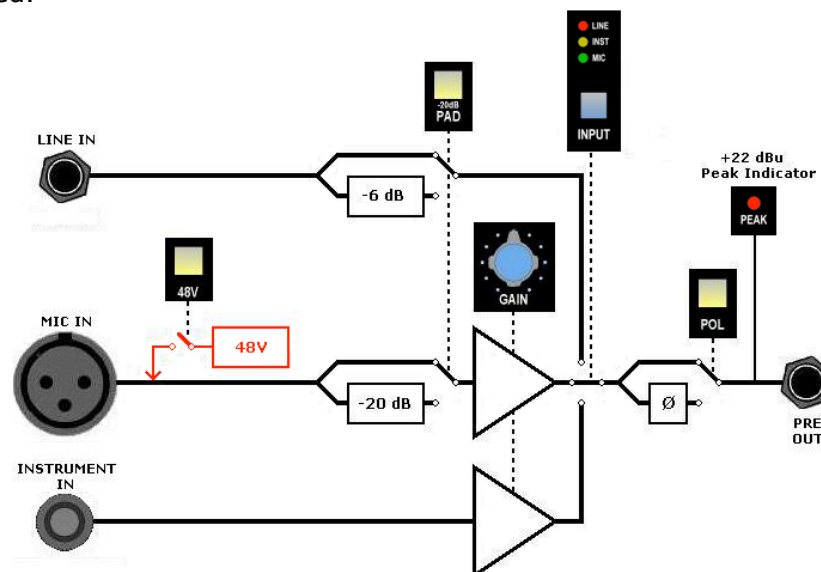

# 4.0 Dynamic Processing: 527A Compressor

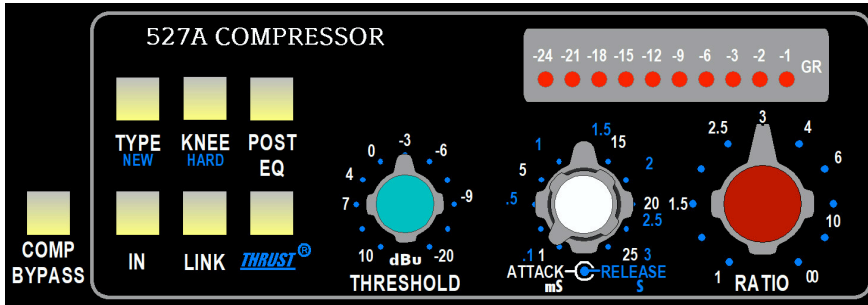

The API 527A Compressor takes its place alongside the family of API VCA based compressors, the 225, 529, and the 2500+ Stereo Bus Compressor. Anyone familiar with those units will immediately be at home with the 527A.

## 4.1 527A Compressor Overview and Features

The 527A Compressor is equipped with functions common to other of compressors in the API line like "feed-forward" (**NEW**) and "feed-back" (**OLD**) gain reduction methods selectable on the front panel, provide a choice of "that old type", or "the new type" of compression, for the highest level of flexibility in signal gain control. The "old type" or feed-back method is what most of the classic compressors used for the gain control circuit. The "new type" gain reduction is more typical of the newer VCA type compressors that rely on RMS detectors for the gain control voltage.

There is a "SOFT"/"HARD" **KNEE** switch for an "over-easy" style of compression resulting in a very natural, uncompressed sound or a typical sharp knee type that lends itself to a much more severe limiting effect.

The patented **THRUST**® function can be switched in and out via the front panel, applying a filter before the RMS detector circuit that preserves a punchy bottom end.

A COMPRESSOR SIDE CHAIN INPUT is provided for keying and external detector path processing.

The 527A Compressor sections of two or more TCS-IIs or other 527/527A compressors can be linked together via a DC LINK allowing multiple units to be combined for stereo and multichannel applications.

The output level remains fairly constant regardless of the threshold or ratio control, much like the "more/less" Ceiling control on the API 525 Compressor. This allows for live adjustments without any noticeable gain changes in the program level.

The 527A Compressor makes use of API 2510 and 2520 op-amps and exhibits the reliability, long life, and signature sound which are characteristic of API products.

### Features:

- **TYPE** switch for "feed-forward" or "feed-back" compression
- **KNEE** switch for hard or soft knee compression
- Patented **THRUST**® function for frequency dependent side chain control
- Continuously variable detented **THRESHOLD** control
- Continuously variable detented **ATTACK** and **RELEASE** controls
- Continuously variable detented **RATIO** control
- 10-segment gain reduction (**GR**) meter
- **IN/out** switch
- **COMP BYPASS** activates hard relay bypass when engaged
- **POST EQ** routing moves the 527A to after the 550A Equalizer
- **LINK** activates multiple unit compression linking (stereo/multichannel compression)
- DC LINK to interface with other 527As for stereo/multichannel operation
- COMPRESSOR SIDE CHAIN INPUT for external keying (**NEW** mode only)
- Audio circuit uses API 2510 and 2520 op-amps



## 4.2 527A Compressor Controls

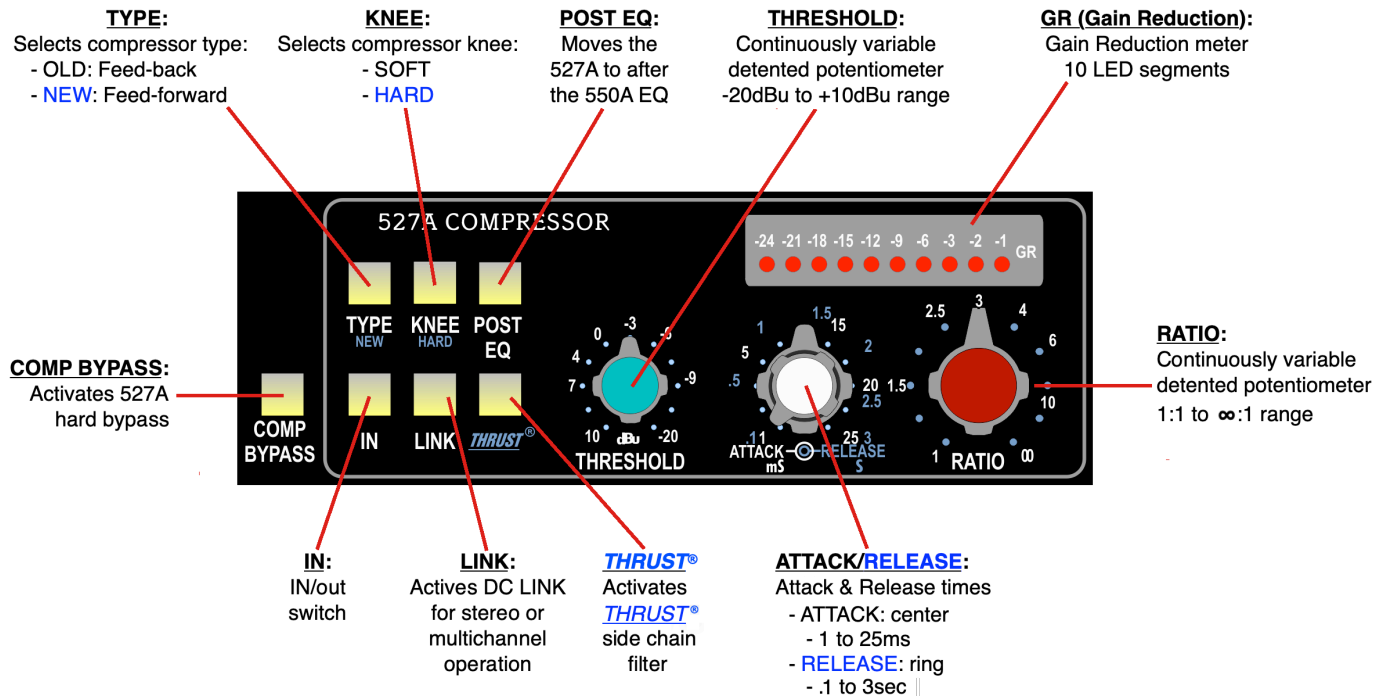

The 527A Compressor provides a comprehensive suite of controls:

- **THRESHOLD:** Sets the level at which compression begins
- **ATTACK:** Sets the time it takes for the compressor to respond
- **RELEASE:** Sets the time it takes the compressor to return to unity gain
- **RATIO:** Sets the amount of compression applied after threshold
- **TYPE:** Selects **NEW** (feed-forward) or **OLD** (feed-back) detection path topology
- **KNEE:** Selects **HARD** or **SOFT** response curve characteristic at the onset of compression
- **THRUST®:** Inserts the patented API high-pass filter before the RMS detector
- **LINK:** Activates the DC LINK for stereo/multichannel processing with other TCS units
- **COMP BYPASS (Compressor Bypass):** Activates the 527A hard bypass in the audio path
- **POST EQ:** Moves the 527A to post the 550A Equalizer in the audio path
- **GR (Gain Reduction):** 10-segment LED gain reduction meter displays compression amount

### 4.2.1 Threshold

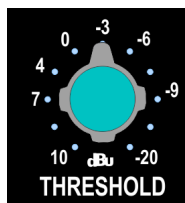

**THRESHOLD:** Sets the level at which compression begins

- Continuously variable between -20dBu and +10dBu
- Detented rotary pot for easy recall

### 4.2.2 Attack and Release



Attack and Release times are fully variable on the 527A Compressor and share a dual-concentric potentiometer for control. **ATTACK** time is adjusted using the outer ring and **RELEASE** time is adjusted using the inner knob.



**ATTACK:** Sets the time it takes the compressor to react when the level exceeds the set THRESHOLD

- Continuously variable between 1ms and 25ms (milliseconds)
- Detented rotary pot for easy recall



**RELEASE:** Sets the time it takes the compressor to recover to unity gain after the level falls below the set THRESHOLD

- Continuously variable between .1s and 3s (seconds)
- Detented rotary pot for easy recall

#### 4.2.3 Ratio

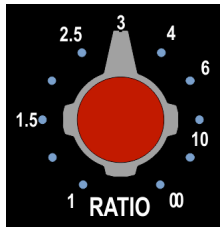

**RATIO:** Sets the ratio of input vs. output levels for signals that fall above the set THRESHOLD

- Continuously variable between 1:1 and  $\infty$ :1
- A Ratio of 10:1 or greater is generally considered to be a limiter
- Detented rotary pot for easy recall

#### 4.2.4 Compression Type

The 527A Compressor can be set to operate in two circuit topologies:

- **OLD:** Feed-Back topology: The RMS detector receives the signal from after the VCA
- **NEW:** Feed-Forward topology: The RMS detector receives the signal from before the VCA

The compressor circuit topology is selected using the **TYPE** switch.



**TYPE:** Selects the compressor circuit topology

- **OLD:** Feed-back detection path topology (default setting)
- **NEW:** Feed-forward detection path topology (switch engaged)
- Illuminates when engaged

#### **OLD:** Feed-Back Compression

In a feed-back compressor, the RMS detector gets its signal from the output of the gain reduction device (VCA). This is how older API 525, 1176 type, and 660 type compressors work. This yields a smoother, softer, more transparent sound.

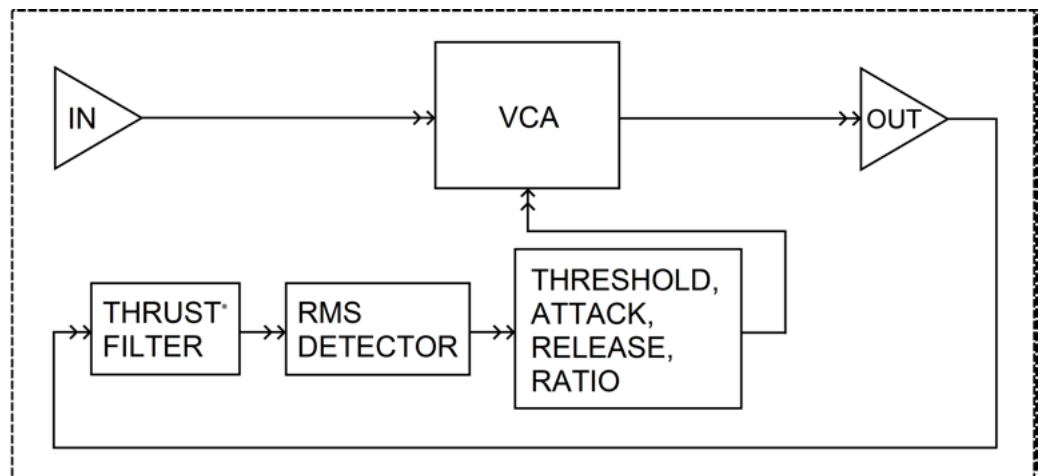

## **NEW:** Feed-Forward Compression

In a feed-forward compressor, the RMS detector normally gets its signal from a split of the input signal.

The detector path can alternately get its signal from a Side Chain Input (not shown).

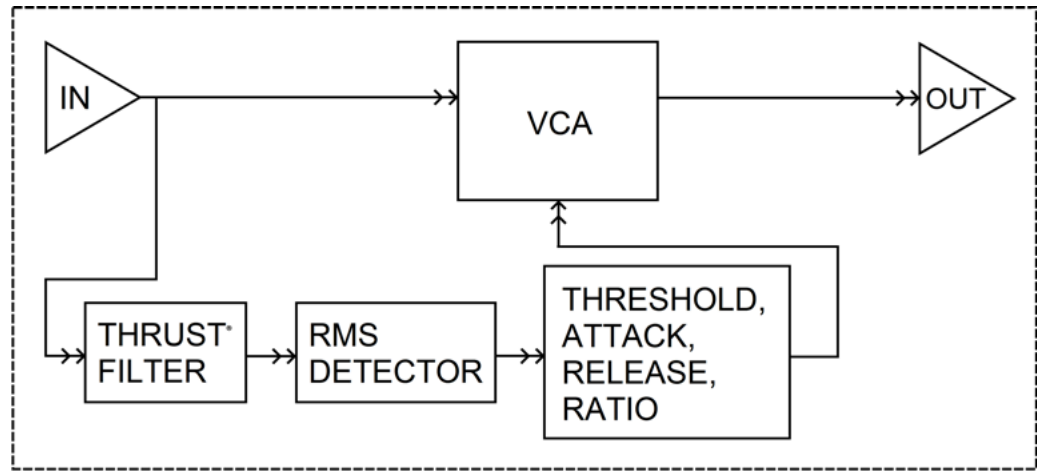

With this method, the RMS detector sends a signal to the VCA that is an exact ratio of the desired compression set by the RATIO control. This is how many new VCA based compressors work. This can yield more aggressive compression and a harder, more affected sound.

### 4.2.5 Compression Knee

**KNEE** determines the 527A Compressor's response curve at the onset of compression.

The 527A Compressor has two (2) knee settings that control how the compressor transitions into compression:

- **SOFT:** Rounded response curve
- **HARD:** Sharp response curve

The knee of the compressor is selected using the **KNEE** switch.



**KNEE:** Selects the response curve at the onset of compression.

- **SOFT:** Rounded, more gradual response curve (default setting)
- **HARD:** Sharper, more aggressive response curve (switch engaged)
- Illuminates when engaged

### Soft Knee Compression

**SOFT:** Rounded, more graduate response curve

- Gradual onset of compression (fade-in up to the set ratio)
- Similar to an "over-easy" type knee
- More transparent



## Hard Knee Compression

**HARD:** Sharper, more aggressive response curve

- Immediate onset of compression (sudden transition to set ratio)
- More aggressive and noticeable

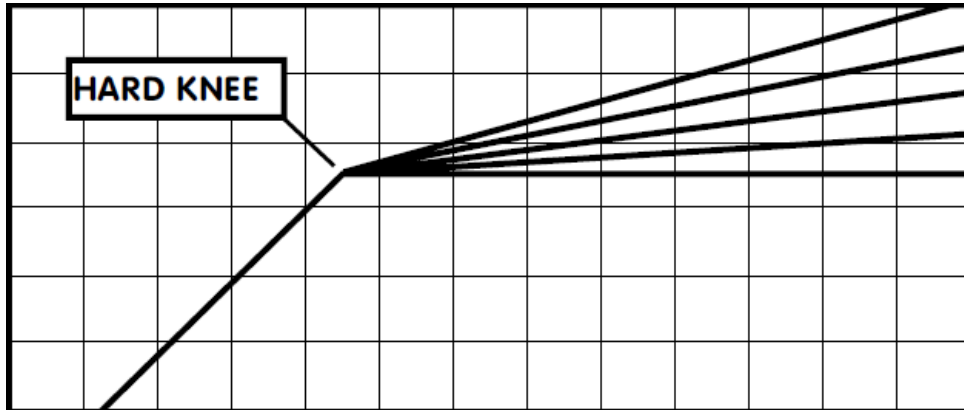

### 4.2.6 **THRUST**<sup>®</sup>

The 527A Compressor includes API's patented **THRUST**<sup>®</sup> circuit that can be switched in or out as needed. This places the **THRUST**<sup>®</sup> filter before the RMS detector that decreases the compressor's reaction to low frequency content. The result is a noticeable increase of punch and low frequencies, but a uniformly compressed signal. It's the "little more punch" switch!

The **THRUST**<sup>®</sup> circuit can be engaged using the **THRUST**<sup>®</sup> switch.



**THRUST**<sup>®</sup>: Inserts the **THRUST**<sup>®</sup> filter before the RMS detector

- Illuminates when engaged

The patented **THRUST**<sup>®</sup> circuit has been used for many years in the famed API 2500 Stereo Compressor, ATI Paragon and Paragon II consoles, as well as the Pro-6 Input Strip. This circuit places a filter in front of the RMS detector with a slope of 10dB per decade (-3dB/8va), which is the inverse of the pink noise energy curve. In acoustics, the pink noise curve is used to equalize energy vs. frequency over the audio spectrum, as sound requires more low frequency energy than high frequency energy to sound correct to your ear. In Hi-fi equipment, a "LOUDNESS" contour is used to equalize the music at lower levels so it sounds correct. Even with this curve, there is still a substantial amount of low frequency information compared to high frequency information in the audio signal path. When that signal is fed into the RMS detector, the detector will process the signal into a DC control voltage based upon the those louder low frequencies, resulting in a control voltage that favors the low frequencies of the signal, causing pumping and a loss of punch. Sometimes, this is not desirable. By engaging the **THRUST**<sup>®</sup> switch, this inverse filter is placed in front of the RMS detector, evening out the energy by lowering the energy in the low frequencies and increasing the energy in the high frequencies, so each octave has the same energy instead of each octave having half the energy as the one lower. This creates a unique compression effect that still reduces the overall gain, but the sound is much more punchy and the signal actually sounds less compressed.

### 4.2.7 Gain Reduction Meter

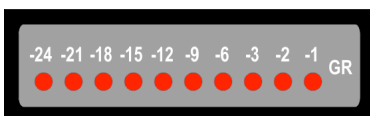

A gain reduction (GR) meter is provided to indicate the amount of compression being applied.

When no gain reduction is being applied, none of LED's are lit on the Gain Reduction meter (GR). When compression occurs, the corresponding LED's illuminate to indicate the amount of gain reduction. The following gain reduction increments are provided:

- -1dB
- -2dB
- -3dB
- -6dB
- -9dB
- -12dB
- -15dB
- -18dB
- -21dB
- -24dB

*NOTE: There is an internal option to change the operation of the GR meter to reverse the operation of the meter so it matches the operation of original units. With this option engaged, when no gain reduction is being applied, all LED's are lit on the Gain Reduction meter (**GR**). When compression occurs, the corresponding LED's extinguish to indicate the amount of gain reduction.*

## 4.3 527A Compressor Routing

There are four (4) routing options for 527A Compressor:

- Pre EQ: The 527A Compressor is located after the preamp and before the EQ (default signal flow)
- Post EQ: The 527A Compressor is located after the EQ and before the output section
- Hard Bypassed: The 527A Compressor is removed completely from the audio path
- Side Chain Input: An external signal can replace the normal detector path input (**NEW** mode only)

### 4.3.1 Compressor Pre Equalizer (Default Signal Flow)

In the default signal flow (no routing switches engaged), the 527A Compressor receives the output of the 512C Preamp.

- 527A Compressor will interface via the FIRST EFFECT jacks on the rear panel
- 550A Equalizer will interface via the SECOND EFFECT jacks on the rear panel

### 4.3.2 Compressor Post Equalizer

When the **POST EQ** switch is engaged, the 527A Compressor receives the output of the 550A Equalizer and is interfaced via the SECOND EFFECT jacks on the rear panel.



- POST EQ:** Moves the 527A Compressor to after the 550A Equalizer in the audio path
- 527A Compressor will interface via the SECOND EFFECT jacks on the rear panel
  - 550A Equalizer will interface via the FIRST EFFECT jacks on the rear panel
  - Illuminates when engaged

### 4.3.3 Compressor Bypass

When the **COMP BYPASS** switch is engaged, the 527A Compressor is completely removed from the audio path via a hard relay-based bypass.



- COMP BYPASS (Compressor Bypass):** Engages the 527A Compressor hard bypass in the audio path
- Relay hard bypass
  - Illuminates when engaged

### 4.3.4 Compressor IN Switch

To emulate the API 500 Series version of the 527A, the compressor in the TCS-II is equipped with an internal **IN**/out switch. The **IN** switch must be engaged for compression to have effect.



- IN:** Activates the 527A Compressor
- Illuminates when engaged

## 4.4 527A Compressor Side Chain

The 527A Compressor side chain is the detector path that contains the **THRUST**<sup>®</sup> filter and RMS detector. When the compressor **TYPE** is set to **NEW**, the side chain is fed from the 527A input. When the **NEW** type is selected, the side chain signal can alternately be fed from an external signal via the COMPRESSOR SIDE CHAIN IN jack on the rear panel.

The 527A Compressor side chain (detector path) is accessible via a balanced ¼" line-level input on the rear panel.

When the compressor type is set to **NEW**, the 527A Compressor side chain is fed by a split of the input to the compressor. The detection path signal can be replaced by an external source by inserting a plug in the COMPRESSOR SIDE CHAIN IN jack on the rear panel.



**COMPRESSOR SIDE CHAIN IN:** Replaces the signal feeding the compressor detector path with the inserted signal:

- Inserting a plug will replace the default side chain signal (EFFECT 1)
- Only active when compressor is set to **NEW** type
- Balanced, low-impedance +4dBu line-level input
- Switching ¼" TRS jack

*NOTE: The COMPRESSOR SIDE CHAIN IN, is not operable when the compressor **TYPE** switch is set to **OLD** (not engaged).*

## 4.5 527A DC Link

The 527A Compressor in the TCS-II can be linked with 527/527A compressors in other units for stereo and multichannel applications. When connected together and the **LINK** switches are engaged, the DC control voltages from all units are summed together. This results in the same control changes being applied to all compressors. Because this is not a "Master/Slave" configuration, the **THRESHOLD**, **ATTACK/RELEASE** times, and **RATIO** of all units should be set to the same values to prevent one channel from generating a disproportionate contribution to the summed control voltage.



**DC LINK:** Control voltage input/output jack for the 527A Compressor

- Active only when **LINK** switch is engaged
- All DC LINK cables are ¼" TRS phone plugs wired tip-to-tip, ring-to-ring, and sleeve-to-sleeve
  - **Stereo:** Cable with a ¼" TRS on each end
  - **Multichannel:** Cable with multiple ¼" TRS plugs



- LINK:** Activates the DC control voltage summing with other units
- Illuminates when engaged

# 5.0 Spectral Processing: 550A Equalizer

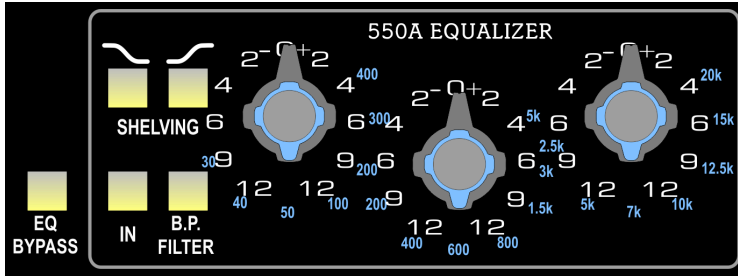

Few equalizers enjoy the respect and admiration of the coveted API 550A Equalizer. Designed by the legendary Saul Walker in the late '60s, the 550A Equalizer was first used as a modular OEM equalizer.

## 5.1 550A Equalizer Overview and Features

As the industry rapidly embraced the sonic quality of the 550A Equalizer, it quickly found its way into many custom console designs by Frank DeMedio and other leading engineers. Many of these consoles are still in use today.

Over fifty years later, the 550A Equalizer remains the standard against which other EQs are measured, and it has played a major role in the recording industry for decades. Still copied but never duplicated, the 550A Equalizer became API's standard channel module EQ when the company began manufacturing consoles in 1971. With virtually all existing units spoken for, popular demand for this EQ resulted in API finally resuming production in 2004.

The 550A Equalizer provides reciprocal equalization at 21 fixed frequencies (seven per band) in 5 fixed steps of boost or cut with a maximum of 12dB of gain or attenuation at each band. The 21 equalization frequencies are divided into three overlapping ranges (bands). The high and low frequency ranges are individually selectable as either peaking or shelving, and a band-pass filter may be inserted independently of all other selected equalization settings. Frequency ranges and boost or cut are selected by three dual-concentric switches, and a pushbutton "IN" switch allows the EQ to be silently introduced into the signal path. The **B.P. FILTER** switch is used to insert the band-pass filter into the 550A Equalizer.

The combination of Walker's incomparable 2520 op-amp and his "Proportional Q" circuitry gives the 550A Equalizer user an uncomplicated way to generate acoustically superior equalization. This EQ, that has had such a huge part in the history of recording, is continuing to make history in today's music.

### Features:

- 3 bands of classic API equalization
- Each band offers seven (7) API selected frequency centers
- Reciprocal and repeatable filtering
- Maximum 12dB of boost/cut per band
- Low and High EQ bands offer shelf/peak switching
- "Proportional Q" narrows filter Q at extremes
- Band-pass filter (-3dB @ 50Hz and 15kHz)
- High headroom +30dB clip level
- Traditional API circuit design using the 2520 op-amps



## 5.2 550A Equalizer Controls

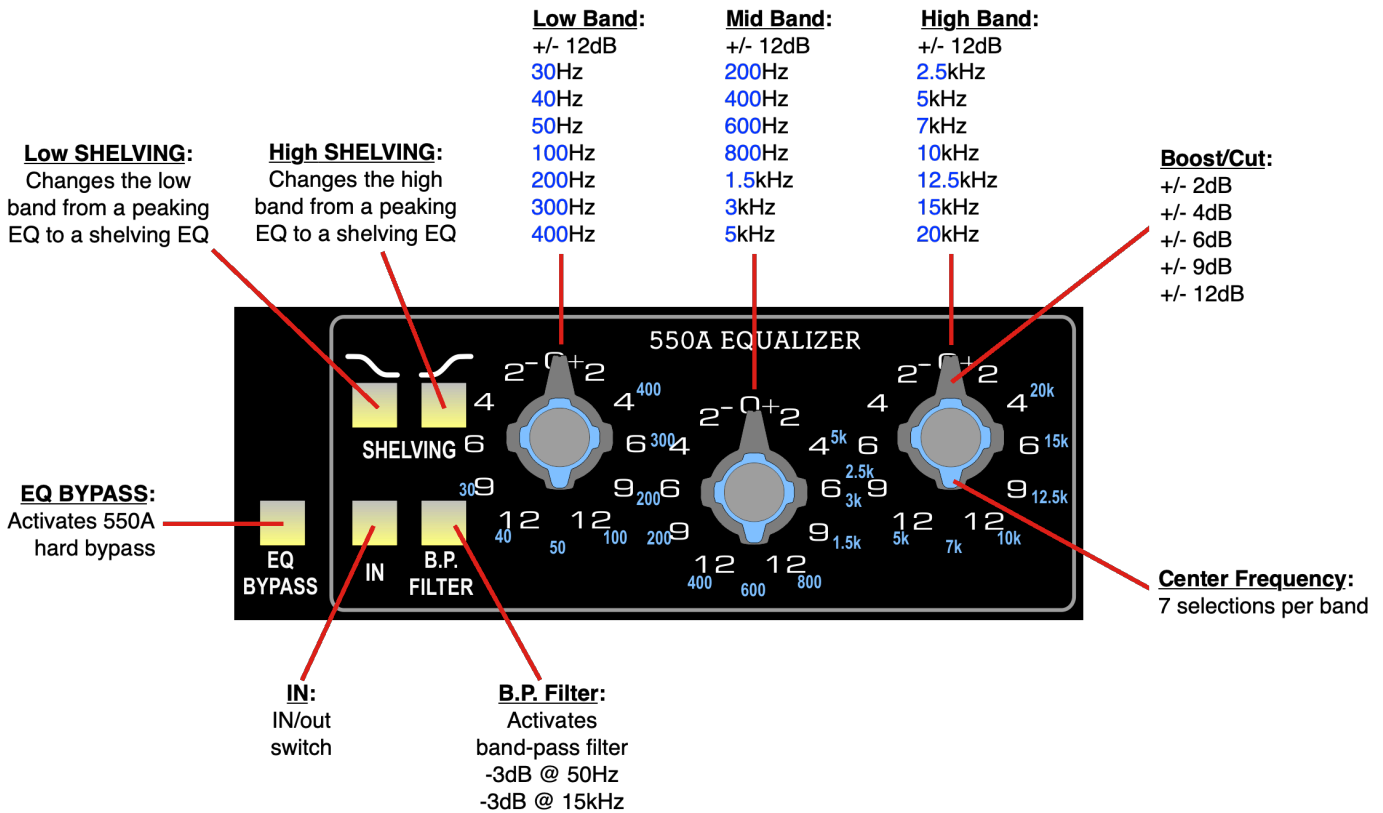

The 550A Equalizer provides three (3) bands of equalization and a band-pass filter.

- **Center Frequency (center knob):** Seven (7) center frequencies indicated in blue numbers
- **Boost/Cut (Ring):** +/- 12dB of boost/cut indicated in white numbers
- **High SHELVING:** High band peaking/shelving switch
- **Low SHELVING:** Low band peaking/shelving switch
- **B.P. Filter:** Activates band-pass filter (-3dB @ 50Hz and 15kHz)
- **IN/out switch**
- **EQ BYPASS** activates hard relay bypass when engaged

### 5.2.1 Low Frequency Band

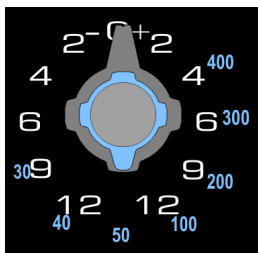

#### **Low Frequency:**

- **Center Frequency (knob):**
  - 30Hz, 40Hz, 50Hz, 100Hz, 200Hz, 300Hz, 400Hz
- **Boost/Cut (ring):** +/- 12dB
  - +/- 2dB, 4dB, 6dB, 9dB, 12dB
- Switchable shelving



**Low Frequency SHELVING:** Changes the low frequency band from a peaking EQ to a shelving EQ

- All frequencies below the selected center frequency will be boost or cut
- Illuminates when engaged



## 5.2.2 Mid Frequency Band

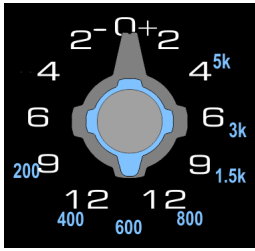

### Mid Frequency:

- **Center Frequency (knob):**
  - 200Hz, 400Hz, 600Hz, 800Hz, 1.5kHz, 3kHz, 5kHz
- **Boost/Cut (ring):** +/- 12dB
  - +/- 2dB, 4dB, 6dB, 9dB, 12dB

## 5.2.3 High Frequency Band

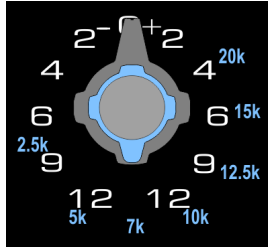

### High Frequency:

- **Center Frequency (knob):**
  - 2.5kHz, 5kHz, 7kHz, 10kHz, 12.5kHz, 15kHz, 20kHz
- **Boost/Cut (ring):** +/- 12dB
  - +/- 2dB, 4dB, 6dB, 9dB, 12dB
- Switchable shelving



**High Frequency SHELIVING:** Changes the high frequency band from a peaking EQ to a shelving EQ

- All frequencies above the selected center frequency will be boost or cut
- Illuminates when engaged

## 5.2.4 Band-Pass Filter

A -3dB @ 50Hz and -3dB @ 15kHz band-pass filter can be inserted in the 550A Equalizer audio path by engaging the **B.P. FILTER** switch.



**B. P. FILTER:** Activates the band-pass filter

- -3dB @ 50Hz and -3dB @ 15kHz
- Illuminates when engaged

## 5.3 550A Equalizer Routing

There are three (3) routing options for 550A Equalizer:

- Post Compressor: The 550A Equalizer is located after the compressor and before the 325 output section (default signal flow)
- Pre Compressor: The 550A Equalizer is located after the 512C Preamp and before the 527A Compressor
- Hard Bypassed: The 550A Equalizer is removed completely from the audio path

### 5.3.1 Equalizer Post Compressor Pre (Default Signal Flow)

In the default signal flow (no routing switches engaged), the 550A Equalizer receives the output of the 527A Compressor.

- 512C Preamp will feed the 527A Compressor via FIRST EFFECT jacks
- 527A Compressor will interface via the FIRST EFFECT jacks on the rear panel
- 550A Equalizer will interface via the SECOND EFFECT jacks on the rear panel

### 5.3.2 Equalizer Pre Compressor

When the **POST EQ** switch is engaged, the 550A Equalizer is placed before the 527A Compressor in the signal flow and receives the output of the 512C Preamp. The 550A is interfaced via the FIRST EFFECT jacks on the rear panel.



- POST EQ:** Moves the 527A Compressor to after the 550A Equalizer in the audio path
- 550A Equalizer will interface via the FIRST EFFECT jacks on the rear panel
  - 527A Compressor will interface via the SECOND EFFECT jacks on the rear panel
  - Illuminates when engaged

### 5.3.3 Equalizer Bypass

When the **EQ BYPASS** switch is engaged, the 550A Equalizer is completely removed from the audio path via a hard relay-based bypass.



- EQ BYPASS (Equalizer Bypass):** Engages the 550A Equalizer hard bypass in the audio path
- Relay hard bypass
  - Illuminates when engaged

### 5.3.4 Equalizer IN Switch

To emulate the API 500 Series version of the 550A, the equalizer in the TCS-II is equipped with an internal **IN**/out switch. When the engaged, the equalizer is in the audio path.



- IN:** Activates the 550A Equalizer
- Illuminates when engaged

## 6.0 Output Section: 325 Line-Driver

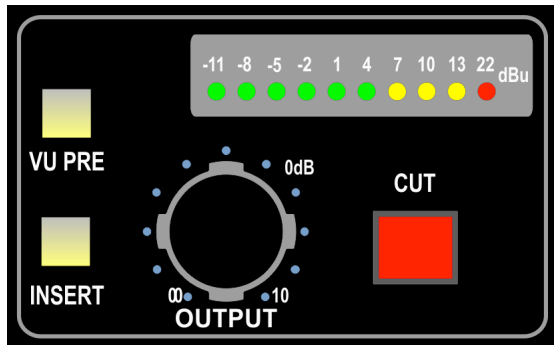

The output section of the TCS-II includes an insert, **OUTPUT** level potentiometer, soft mute (**CUT**), and the API 325 Line-Driver output circuit (a 2520 and 1:3 output transformer) taken directly from API console designs.

The 10-segment LED level meter can be switched to monitor the output level of the TCS-II or the output of the 512C Preamp.

### Features:

- **INSERT:** Switchable insert return
- **CUT:** Soft output mute
- **OUTPUT** fade with full attenuation to +10dB of gain range
- Routable 10-segment LED dBu level meter displays 512C output or main output level
- High headroom +30dB clip level
- API circuit design using the API 2520 op-amp with output transformer

## 6.1 325 Output Section Overview and Controls

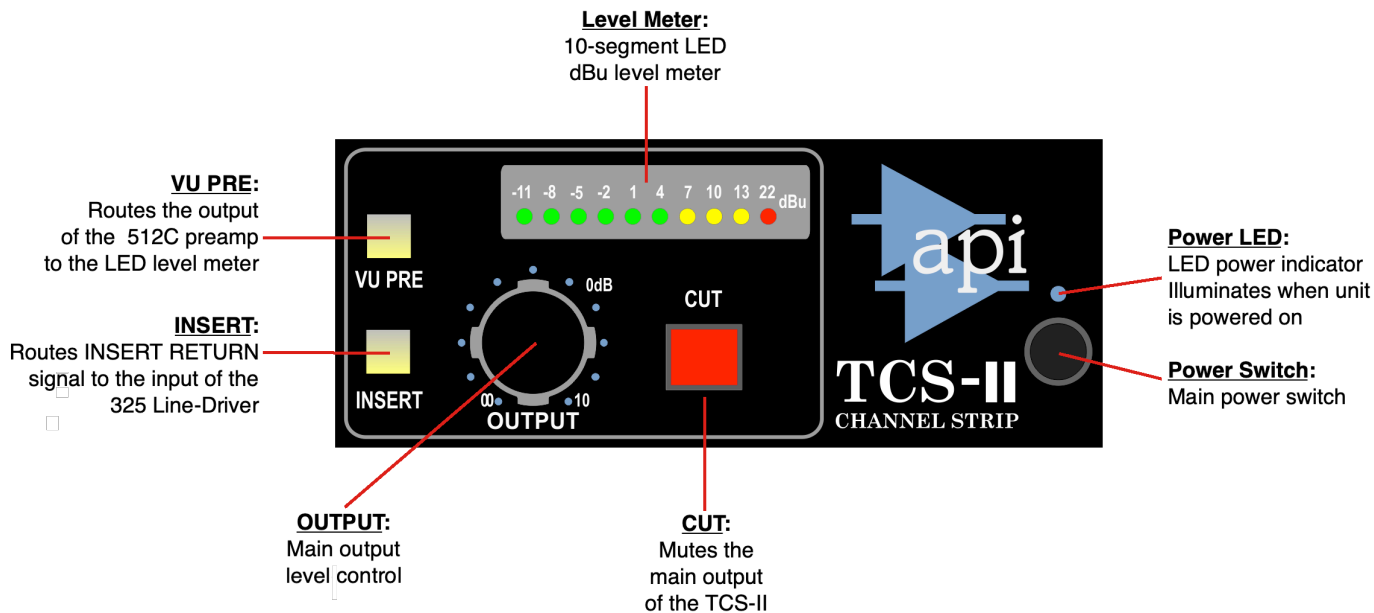

The 325 Line-Driver provides the following controls:

- **OUTPUT:** Main output level control
- **CUT:** Silent soft main output mute
- **INSERT:** Replaces the output of the Second Effect with the signal at Insert Return as the input to the 325 Line-Driver section
- **VU PRE:** Routes the output of the 512C Preamp to the level meter
- **Level Meter:** Routable 10-segment LED dBu level meter
- **Power:** AC power switch and LED indicator

### 6.1.1 Output

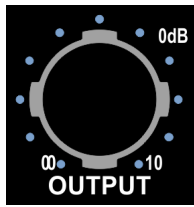

- OUTPUT:** Main output level potentiometer
- Full attenuation ( $-\infty$ ) to +10dB range
  - Detented rotary pot for easy recall



- CHANNEL OUT:** Main TCS-II output
- Fed from 325 Line-Driver
  - Balanced, low-impedance, +4dBu line-level
  - Male 3-pin XLR connector

### 6.1.2 Soft Mute

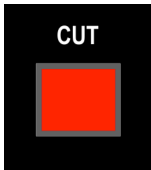

- CUT:** Mutes main TCS-II output
- Silent soft mute
  - Illuminates in red when engaged

### 6.1.3 Insert

Engaging the **INSERT** switch will route the signal present at the INSERT RETURN jack to the input of the 325 Line-Driver. When the **INSERT** switch engaged, the signal flow will be as follows:



- INSERT:** Activates the INSERT RETURN input
- Routes the signal present at the INSERT RETURN jack to the 325 Line-Driver
  - Replaces the Second Effect output as the input to the 325 Line-Driver
  - Illuminates when engaged

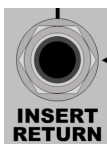

- INSERT RETURN:** Replaces the input to 325 Line-Driver when the **INSERT** switch is engaged
- Only active when **INSERT** switch is engaged
  - Balanced, low-impedance, +4dBu line-level input
  - 1/4" tip-ring-sleeve jack

*NOTE: Since the signal can be externalized at multiple points in the audio path, the TCS-II does not have a dedicated "insert send" output. PRE OUT, FIRST EFFECT OUT, and SECOND EFFECT OUT are intended to be used as "insert sends" as needed.*

### 6.1.4 Level Meter



The 10-segment LED dBu level meter will normally display the output of the 325 Line-Driver.

The output of the 512C Preamp will be displayed the when the **VU PRE** switch is engaged.



**VU PRE:** Routes the output of the 512C Preamp to the level meter input

- Illuminates when engaged

## 6.2 325 Output Section Routing

The output section is the last stage in the audio path and provides the Insert, level meter, 325 Line-Driver, and main CHANNEL OUTPUT XLR interface.

The 325 Line-Driver can be fed from two (2) sources:

- **SECOND EFFECT OUT:** The signal present at the SECOND EFFECT OUT jack is normalled to the 325 Line-Driver input.
- **INSERT RETURN:** The signal present at the INSERT RETURN jack will be routed to the 325 Line-Driver input when the **INSERT** switch is engaged.

The output of the Second Effect (normally the 550A Equalizer) is sent to the input to the 325 Line-Driver, as well as the SECOND EFFECT OUT jack on the rear panel. This signal can be replaced by the signal present at the INSERT RETURN jack on the rear panel by engaging the **INSERT** switch.

## 6.3 325 Output Section Block Diagram

The block diagram below illustrates signal flow through the 325 Line-Driver output section of the TCS-II with only the **CUT** switch engaged.

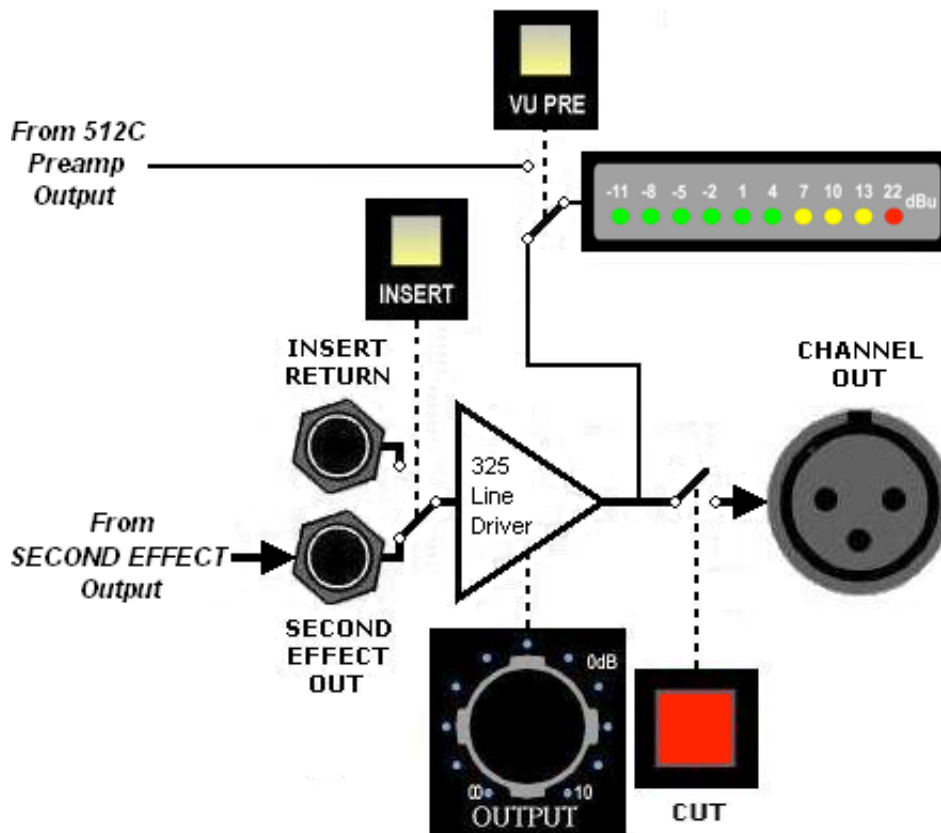

# 7.0 Rear Panel Interface

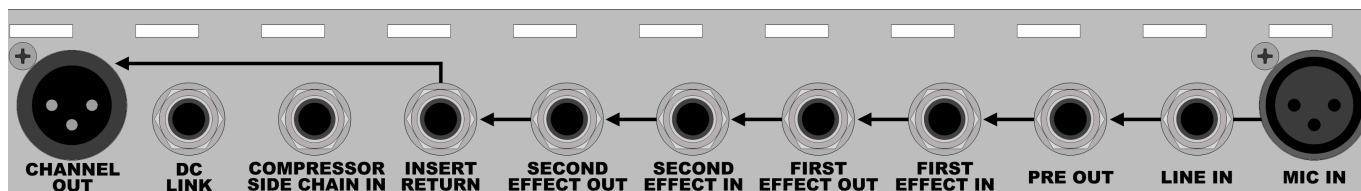

The rear panel of the TCS-II provides a comprehensive package of interfacing options.

With the exception of the microphone and instrument inputs, all audio inputs and outputs are balanced, low-impedance, +4dBu line-level connections. All 1/4" connectors are tip-ring-sleeve phone jacks.

## 7.1 Audio Path Inputs

The TCS-II provides multiple audio inputs at various points in the audio path:



**INST (Instrument):** Instrument-level input to the 512C Preamp (front panel)

- 1/4" tip-sleeve jack
- -10dBu instrument-level
- Unbalanced
- High-impedance



**MIC IN:** Microphone input to the 512C Preamp

- Female, 3-pin XLR
- Balanced
- Low-impedance



**LINE IN:** Line-level input to the 512C Preamp

- 1/4" tip-ring-sleeve jack
- +4dBu line-level
- Balanced
- Low-impedance

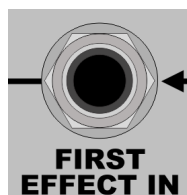

**FIRST EFFECT IN:** Line-level input to the first signal processor in audio path

- Half-normal feed from PRE OUT
  - Inserted signal will break the normal from PRE OUT
- Switching 1/4" tip-ring-sleeve jack
- +4dBu line-level
- Balanced
- Low-impedance

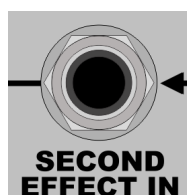

**SECOND EFFECT IN:** Line-level input to the second signal processor in audio path

- Half-normal feed from FIRST EFFECT OUT
  - Inserted signal will break the normal from the FIRST EFFECT OUT
- Switching 1/4" tip-ring-sleeve jack
- +4dBu line-level
- Balanced
- Low-impedance

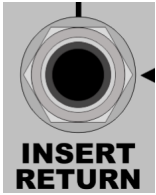

**INSERT RETURN:** The signal present at this jack will replace the input to the 325 Line-Driver when the **INSERT** switch is engaged

- The 325 Line-Driver is normally fed from the SECOND EFFECT OUT
- Engaging the **INSERT** switch will break the normal from the SECOND EFFECT OUT and the INSERT RETURN will feed the 325 Line-Driver
- ¼" tip-ring-sleeve jack
- +4dBu line-level
- Balanced
- Low-impedance

The SECOND EFFECT OUT jack will feed the 325 Line-Driver unless the **INSERT** switch is engaged. If the **INSERT** switch is engaged, the signal patched into the INSERT RETURN JACK will feed the 325 Line-Driver.



**INSERT:** Activates the INSERT RETURN input

- Routes the signal present at the INSERT RETURN jack to the 325 Line-Driver
- Replaces the Second Effect output as the input to the 325 Line-Driver
- Illuminates when engaged

## 7.2 Audio Path Outputs

The TCS-II provides multiple audio outputs at various points in the audio path. All ¼" outputs are non-switching jacks so inserting a plug will not break the connection with the input it feeds.

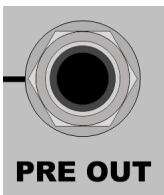

**PRE OUT:** Direct output of the 512C Preamp

- Half-normal feed to FIRST EFFECT IN
  - Plugging into the PRE OUT jack does not break the connection to the FIRST EFFECT IN jack
- ¼" tip-ring-sleeve jack
- +4dBu line-level
- Balanced
- Low-impedance

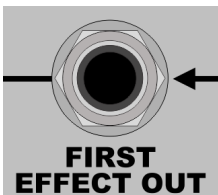

**FIRST EFFECT OUT:** Output from the first signal processor in the audio path

- Half-normal feed to SECOND EFFECT IN
  - Plugging into the FIRST EFFECT OUT jack does not break the connection to the SECOND EFFECT IN jack
- ¼" tip-ring-sleeve jack
- +4dBu line-level
- Balanced
- Low-impedance

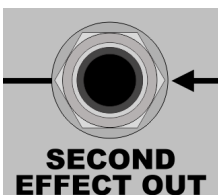

**SECOND EFFECT OUT:** Output from the second signal processor in the audio path

- Normally feeds the input to the 325 output section
  - Plugging into the SECOND EFFECT OUT jack does not break the connection to the 325 output section
- ¼" tip-ring-sleeve jack
- +4dBu line-level
- Balanced
- Low-impedance

The SECOND EFFECT OUT jack will feed the 325 Line-Driver unless the **INSERT** switch is engaged. If the **INSERT** switch is engaged, the signal patched into the INSERT RETURN JACK will feed the 325 Line-Driver.

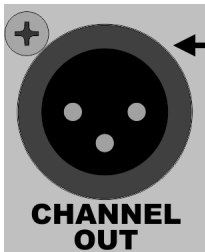

**CHANNEL OUT:** Main TCS-II audio output

- Fed from the 325 Line-Driver
- Male, 3-pin XLR
- +4dBu line-level
- Balanced
- Low-impedance

## 7.3 Audio Path Half-Normals

There are two “half-normalled” connections on the rear panel. Switching jacks are used on the FIRST EFFECT IN and SECOND EFFECT IN, so the signal fed from the normal will be broken when a plug is inserted.

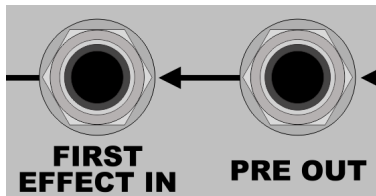

**PRE OUT to FIRST EFFECT IN:** (Normally 512C output to 527A input)

- PRE OUT is a splitting jack and the signal will not be broken when a plug is inserted
- FIRST EFFECT IN is a switching jack and feed from PRE OUT will be broken when a plug is inserted

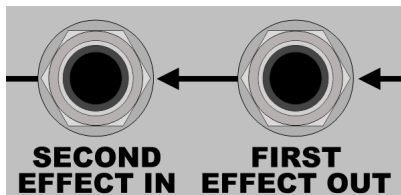

**FIRST EFFECT OUT to SECOND EFFECT IN:** (Normally 527A output to 550A input)

- FIRST EFFECT OUT is a splitting jack and the signal will not be broken when a plug is inserted
- SECOND EFFECT IN is a switching jack and feed from PRE OUT will be broken when a plug is inserted

The SECOND EFFECT OUT jack will feed the 325 Line-Driver unless the **INSERT** switch is engaged. If the **INSERT** switch is engaged, the signal patched into the INSERT RETURN JACK will feed the 325 Line-Driver.



**SECOND EFFECT OUT to 325 Line-Driver In:** (Normally 550A Equalizer output to 325 input)

- SECOND EFFECT OUT is a splitting jack and the signal will not be broken when a plug is inserted
- INSERT RETURN will replace the input to the 325 Line-Driver when the **INSERT** switch is engaged



**INSERT:** Activates the INSERT RETURN input

- Routes the signal present at the INSERT RETURN jack to the 325 Line-Driver
- Replaces the Second Effect output as the input to the 325 Line-Driver
- Illuminates when engaged



## 7.4 527A Compressor Side Chain & DC Link Connections

The 527A Compressor provides two methods of external control:

- COMPRESSOR SIDE CHAIN IN
- DC LINK

### 7.4.1 Side Chain Input

The 527A Compressor side chain is the detector path that contains the **THRUST**<sup>®</sup> filter and RMS detector. When the compressor type is set to **NEW**, the side chain is fed from a split of the 527A Compressor input signal. When the **NEW** type is selected, the side chain signal can alternately be fed from an external signal via the COMPRESSOR SIDE CHAIN IN jack on the rear panel.

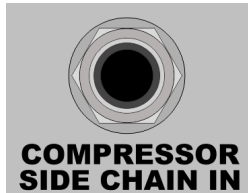

**COMPRESSOR SIDE CHAIN IN:** Input to the 527A Compressor detector path

- Inserting a plug will replace the side chain signal
- Only available when the **NEW** compressor type is selected
- Switching ¼" tip-ring-sleeve jack
- +4 dBu line-level
- Balanced
- Low-impedance

### 7.4.2 DC Link

The 527A Compressor in the TCS-II can be linked with 527/527A compressors in other units for stereo and multichannel applications. When connected together and the **LINK** switches are engaged, the DC control voltages from all units are summed together. This results in the same control changes being applied to all compressors. Because this is not a "Master/Slave" configuration, the **THRESHOLD**, **ATTACK/RELEASE** times, and **RATIO** of all units should be set to the same values to prevent one channel from generating a disproportionate contribution to the summed control voltage.

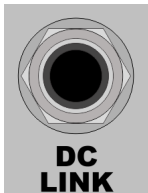

**DC LINK:** Control voltage input/output jack for the 527A Compressor

- Active only when **LINK** switch is engaged
- All DC LINK cables are ¼" TRS phone plugs wired tip-to-tip, ring-to-ring, and sleeve-to-sleeve
  - **Stereo:** Cable with a ¼" TRS on each end
  - **Multichannel:** Cable with multiple ¼" TRS plugs



**LINK:** Activates the DC control voltage summing with other units

- Illuminates when engaged

## 7.5 Rear Panel Signal Flow

The TCS-II signal flow is illustrated by the right-to-left order of the unit's rear panel. This order of these interfaces remains constant, regardless of the order of the 527A Compressor and 550A Equalizer in the signal path.

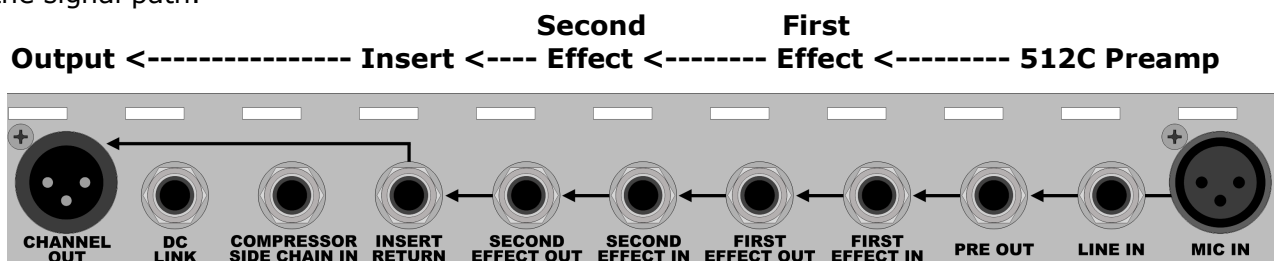

- The PRE OUT is “half-normalled” to feed the FIRST EFFECT IN
- The FIRST EFFECT IN feeds the first processor in the audio path (normally the 527A Compressor\*)
- The FIRST EFFECT OUT is “half-normalled” to feed the SECOND EFFECT IN
- The SECOND EFFECT IN feeds the second processor in the audio path (normally the 550A Equalizer\*)
- The SECOND EFFECT OUT is “half-normalled” to feed the 325 Line-Driver input

\* Engaging the **POST EQ** switch will move the 527A Compressor to after the 550A Equalizer, reversing the order of these effects in the audio path.

The PRE OUT, FIRST EFFECT OUT, and SECOND EFFECT OUT jacks are all splitting outputs. This means the connection to the input they’re normalled to will not be broken when a plug is inserted.

The FIRST EFFECT IN and SECOND EFFECT IN jacks are all switching jacks, so connection with the output they’re normalled to is broken when a plug is inserted. The input is instead fed with the signal present on the inserted plug.

The INSERT RETURN is only active when the **INSERT** switch on the front panel is engaged.

## 8.0 AC Power

The TCS-II can operate on either 115volt or 230volt 50-60Hz AC power.

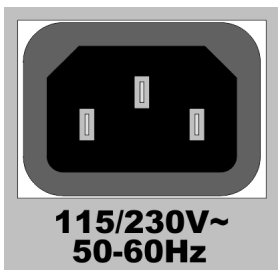

The AC power is supplied via the IEC connector on the rear panel.



Operating voltage is determined by the Voltage Selector switch.

- 115 volts
- 230 volts

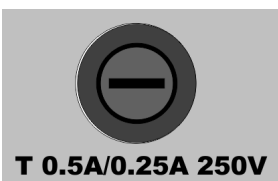

The fuse holder is located on the rear panel.

- 0.5A/0.25A 250V

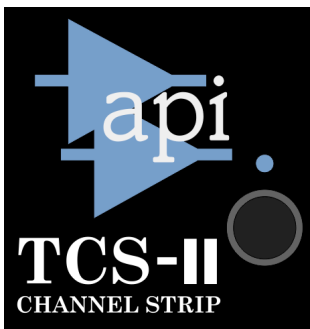

The AC power switch for the TCS-II is located at the lower right of the API logo on the front panel.

- A blue LED indicator illuminates when the unit is on.

# APPENDIX

- A1 TCS-II Technical Specifications**
- A2 TCS-II Block Diagrams**
- A3 TCS-II Setup Sheet**
- A4 API Limited Warranty and Service**

# A1 TCS-II Technical Specifications

## i. 512C Preamplifier Specifications

**Rear Connector:** XLR MIC Input  
Balanced ¼" TRS LINE Input

**Front Connector:** HI-Z ¼" Unbalanced Instrument Input (INST)

**Gain Range:**

MIC: 14dB min. 68dB max.  
INST: 14dB min. 50dB max.

**Maximum Input Levels:**

MIC: +17dBu  
LINE: +36dBu  
INST: +17dBu

**Input Impedance:**

MIC: 1500 Ohms  
LINE: 120K Ohms  
INST: 120K Ohms

**Clipping Level:** +30dBu

**LED Peak Indication:** +22dBu

**Frequency Response:** +0.3dB, -0.1dB, 30Hz to 20kHz

**Signal to Noise Ratio:** MIC:-116dB; INST:-102dB

## ii. 527A Compressor Specifications

**Attack Times:** 1 millisecond to 25 milliseconds (typical)

**Release Times:** 0.1 seconds to 3 seconds (typical)

**Compression Ratios:** 1:1 to ∞:1

**Threshold Control Range:** +10dBu to -20dBu

**Frequency Response:** +/- 0.1dB 20Hz to 20kHz

**Signal to Noise:** -114dB, 20Hz to 20kHz, no compression

**Metering:** 10-segment red LED: Gain Reduction scale; -1dB to -24dB

## iii. 550A Equalizer Specifications

**Insertion Loss:** None (bridging)

**Frequency Response (No equalization):** ±0.2dB 20Hz to 20kHz

**Signal to Noise:** -111dB, 20Hz to 20kHz, no equalization

## iv. 325 Line-Driver Specifications

**Output Fader Control Gain:** -∞ to +10dB

**Clipping Level:** +30dBu

**Channel Output:** +4dBu, Balanced, Low-impedance, Male XLR

**Output Impedance:** Less than 75 Ohms, Transformer Balanced

**Metering:** 10-segment LED: dBu scale; -11dBu to +22dBu  
Switchable between 512C Preamp and 325 Line-Driver outputs

## v. Misc

**Nominal Mains Power Consumption:** 16 watts

**Fusing** 500mA Slow Blow

**Mounting:** Standard EIA rack ears

**Cabling Depth From Mounting Surface:** 13.5"

**Weight:** 10lb 10oz

**Size:** 19x11.5x1.7", L x W x H

**Shipping Weight:** 14lb 9oz

**Shipping Size:** 23.25x16x6.5", L x W x H

**API reserves the right to update or modify any specification listed herein.**

# A2 Block Diagrams

## A2.1 Default Signal Flow

The block diagram below illustrates the TCS-II signal flow with no switches engaged except the **CUT** button. This is the "default" signal flow through the unit.

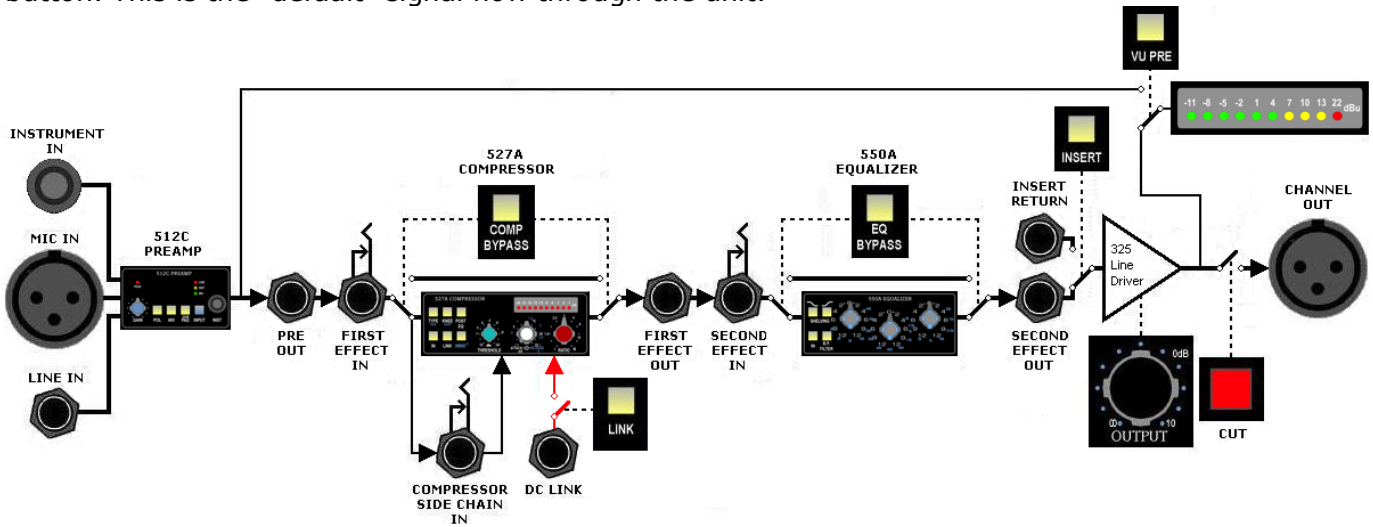

## A2.2 Post EQ Signal Flow

The block diagram below illustrates the TCS-II signal flow with the **POST EQ** switch engaged. No other switches are engaged except the **CUT** button.

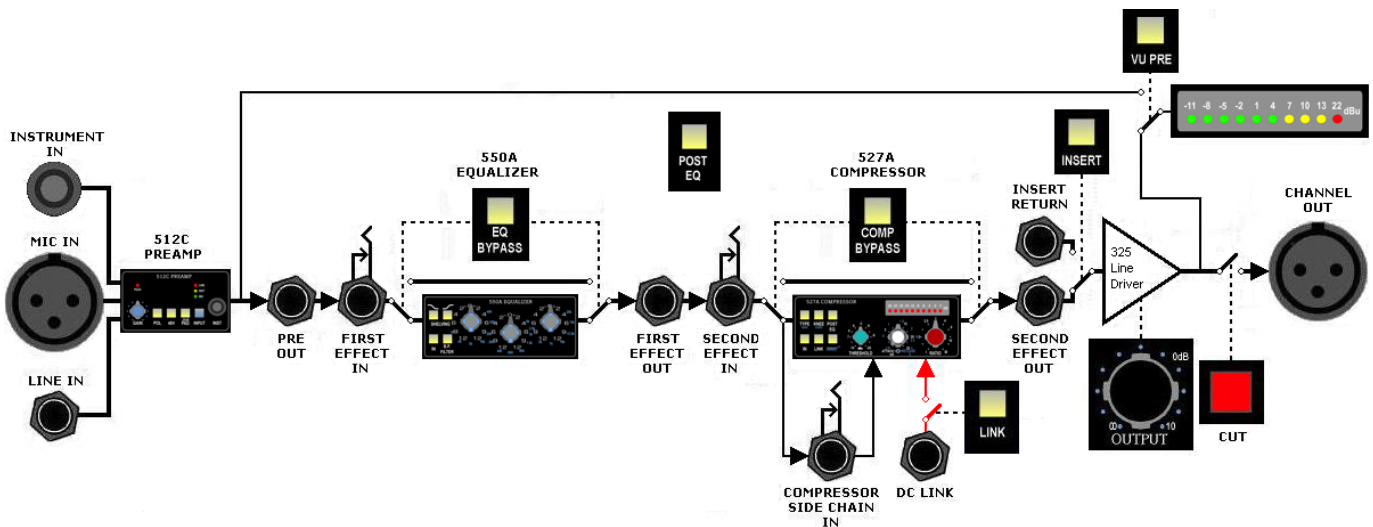

*NOTE: The order of the First and Second Effect jacks on the rear panel does not change with the compressor when the **POST EQ** switch is engaged.*

### A2.3 512C Signal Flow

The block diagram below illustrates signal flow through the 512C Preamp section of the TCS-II with the MIC IN selected as the active input and no switches engaged.

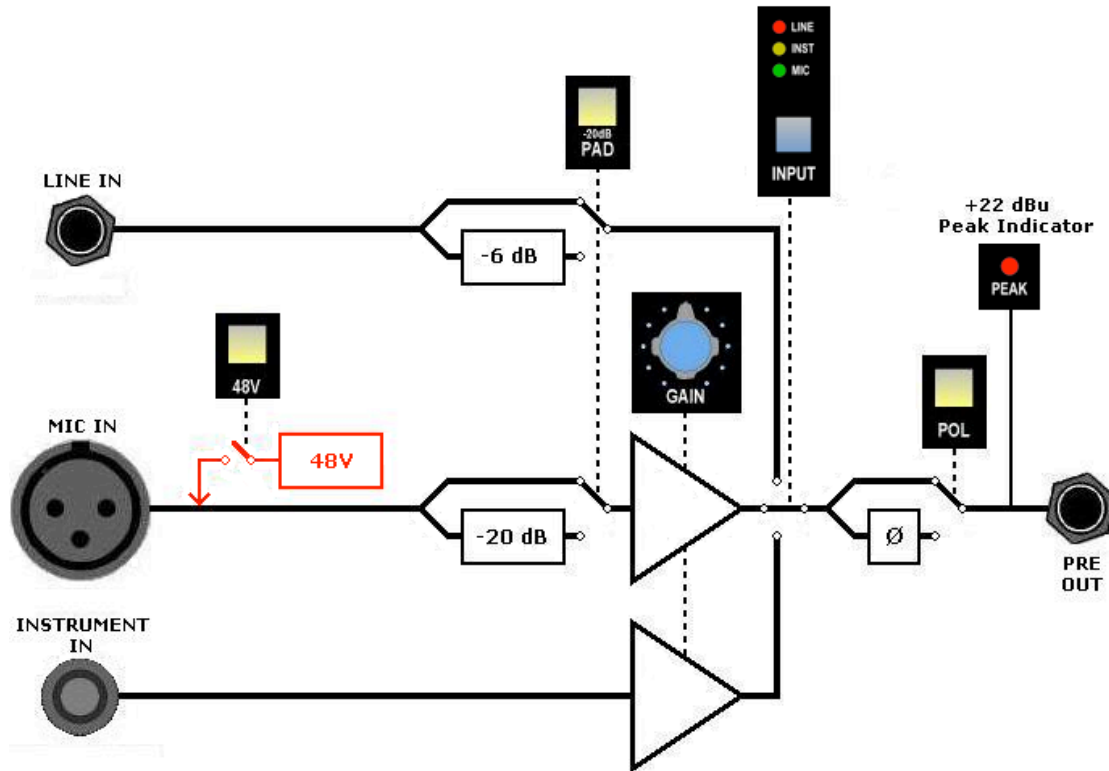

### A2.4 325 Output Section Signal Flow

The block diagram below illustrates default signal flow through the 325 Line-Driver output section of the TCS-II with only the **CUT** switch engaged.

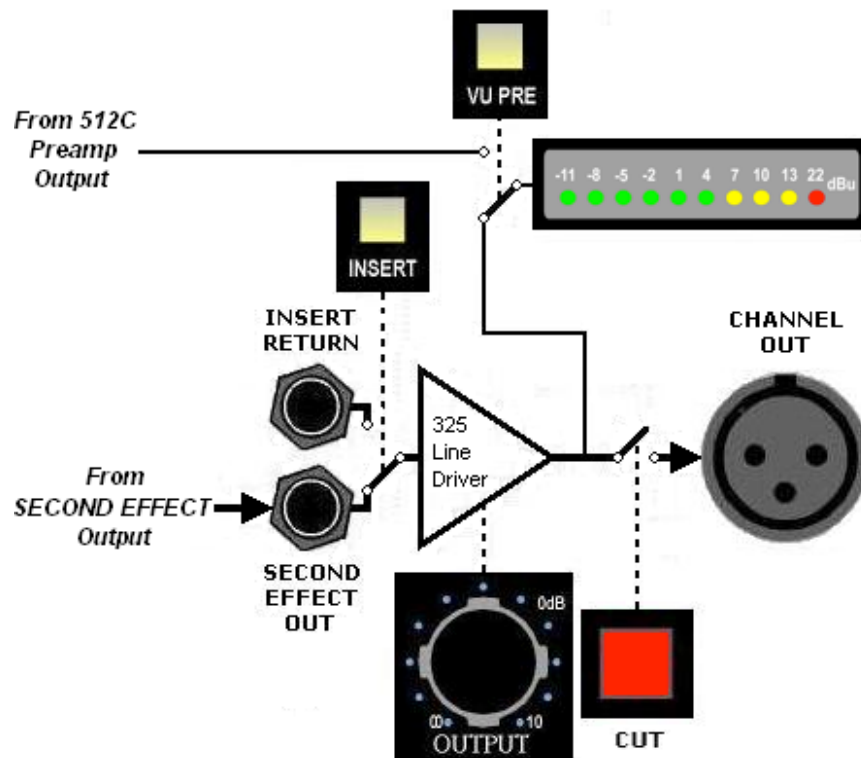

# A3 TCS-II Setup Sheet

**ARTIST:**  
**ENGINEER:**  
**DATE:**

**NOTES:**  
**DRAWN BY:**  
**STUDIO:**

CHAN #	TITLE	NOTES
--------	-------	-------

CHAN #	TITLE	NOTES
--------	-------	-------

CHAN #	TITLE	NOTES
--------	-------	-------

CHAN #	TITLE	NOTES
--------	-------	-------

CHAN #	TITLE	NOTES
--------	-------	-------

CHAN #	TITLE	NOTES
--------	-------	-------



## A4 API Limited Warranty and Service

- a. **Warranty Information:** This product carries a one year labor and a five year parts warranty from date of purchase. API (Automated Processes, Incorporated) does not cover claims for damage due to alteration and/or abuse. This warranty is limited to failures during normal use, which are due to defects in material or workmanship. If any defects are found in the materials or workmanship, or if the product fails to function properly during the applicable warranty period, API, at its option, will repair or replace the product.
- b. **PLEASE NOTE:** The design or quality of any non-authorized third party service or vendor is beyond the control of API. Accordingly service or modification of any API unit except by an authorized API representative may VOID this warranty.
- c. API reserves the right to inspect any products that may be the subject of any warranty claims before repair or replacement is carried out. Final determination of warranty coverage lies solely with API.
- d. This warranty is extended to the original purchaser and to anyone who may subsequently purchase this product within the applicable warranty period. Proof of purchase may be required.
- e. For questions regarding operation, interfacing or service of your API product, please contact your API dealer from whom you purchased the unit. Many times your authorized API dealer is the fastest and most cost-effective way to maintain and service your product.
- f. You may also contact API's Service Department directly.
  - a. Call API at 301-776-7879 (ext. 252) between 8:30 AM and 5:00 PM Monday through Friday (Eastern Time) to get a Return Authorization (RA). Products returned without an RA number may not be accepted.
  - b. Pack the defective part by wrapping in plastic and cushioning material. Seal securely in an approved shipping container. If you do not have a sufficient shipping container, ask API for advice when calling for the RA number.
  - c. Include a note explaining the problem and conditions of the service request. Include your complete return address (no P.O. Boxes, please).
  - d. Ship the product freight prepaid to:

**API**  
**8301 Patuxent Range Road**  
**Jessup, MD 20794**

**IMPORTANT:** Be sure the RA number is plainly written on the shipping carton.

- g. This is your sole warranty. API does not authorize any third party, including any dealer or sales representative, to assume liability on behalf of API or to make any warranty for API.
- h. THE WARRANTY GIVEN ON THIS PAGE IS THE SOLE WARRANTY GIVEN BY API AND IS IN LIEU OF ALL OTHER WARRANTIES, EXPRESS AND IMPLIED, INCLUDING THE WARRANTIES OF MERCHANTABILITY AND FITNESS FOR A PARTICULAR PURPOSE. THE WARRANTY GIVEN ON THIS PAGE SHALL BE STRICTLY LIMITED IN DURATION TO FIVE (5) YEARS FROM THE DATE OF THE ORIGINAL PURCHASE FROM API OR AN AUTHORIZED API DEALER. UPON EXPIRATION OF THE APPLICABLE WARRANTY PERIOD API SHALL HAVE NO FURTHER WARRANTY OBLIGATION OF ANY KIND. API SHALL NOT BE LIABLE FOR ANY INCIDENTAL, SPECIAL, OR CONSEQUENTIAL DAMAGES THAT MAY RESULT FROM ANY DEFECT IN THE API PRODUCT OR ANY WARRANTY CLAIM.

This warranty provides specific legal rights and you may have other rights, which vary from state to state.



Automated Processes, Inc.

**8301 Patuxent Range Road**  
**Jessup, MD 20794 USA**  
**301-776-7879**  
<http://www.apiaudio.com>