

MaxTrap









INSTALLATION MANUAL



Congratulations on purchasing the MaxTrap from Primacoustic. The MaxTrap is an easy to assemble bass trap that will effectively absorb a wide bandwidth of frequencies and look great for years to come. Please take a few minutes to read through this assembly manual. It will give you a list of included parts, as well as step by step assembly and wall mounting instructions. Please refer to www.primacoustic.com for various placement options, benefits, and general room acoustics information. Should you have any questions or comments, we invite you to send an email to: info@primacoustic.com.

HARDWARE BAG CONTENTS:

(QTY) Description:

-  (20) Cam-locks
-  (20) Cam-pins
-  (14) Wooden dowels
-  (10) Medium Phillips screws
-  (8) Short Phillips pan-head screws
-  (2) Long Phillips pan-head screws
-  (4) Heavy duty Phillips screws
-  (4) Plastic drywall anchors

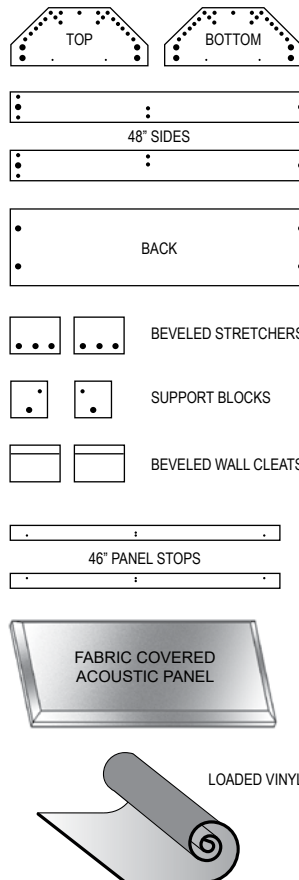

BOX CONTENTS:

Before beginning assembly, please take a moment to familiarize yourself with the box contents.

(QTY) Description:

- (1) Black 'Top' section
- (1) Black 'Bottom' section
- (2) 48" Black side sections
- (1) 48" Back section
- (2) Beveled Stretchers
- (2) Support Blocks
- (2) Beveled Wall Cleats
- (2) 46" Panel Stops
- (1) Fabric wrapped acoustic panel
- (1) Loaded vinyl barrier

TOOLS REQUIRED:

- Large Phillips head screwdriver
- Hammer or mallet
- Bubble Level
- Cordless Drill
- Wall Stud finder (recommended)

Warranty: Please inspect products immediately after receiving your purchase. Primacoustic acoustic products are guaranteed to be free of manufacturing defects for a period of 3 years after purchase. In the unlikely event that a defect is uncovered, please call 604-942-1001 to obtain a RA number (Return Authorization number) from Primacoustic before the 3 year warranty period expires. Once you have obtained a RA number you must return the product, freight prepaid, within fifteen (15) days after the date the RA number is issued. Please return the product in the original packaging (or another, affording an equal degree of protection) with all of the following: (1) RA number clearly marked on the returned package; (2) a receipt or bill of sale showing proof of purchase from an authorized seller; plus (3) a letter describing the defect. Please include your name, address, telephone number and the applicable RA number. You are solely responsible for all shipping and insurance costs for returning the product to Primacoustic, and you will not be reimbursed or compensated for any loss or damage incurred during return shipping. Primacoustic will at its sole discretion repair or replace the product. Should the product no longer be available, Primacoustic reserves the right to exchange this with a product of similar performance and value. Due to different dye lots, Primacoustic cannot guarantee exact color match. This Warranty shall solely extend to the original owner and is limited to manufacturing defects and excludes damage due to improper installation, freight handling, wear and tear, abuse, misuse, misapplication, color fading or deterioration due to prolonged exposure to ultra violet light, smoke, humidity or other environmental factors. It is understood that the use and suitability of the product is entirely the responsibility of the buyer or specifying engineer and as such, these parties agree to hold Primacoustic, or its associated company, and/or officers, harmless from any responsibility whatsoever other than what is clearly outlined in this warranty.

- 1** Place the top and bottom sections on the floor with the pre-drilled holes facing up. Push four cam-locks into each top and bottom section. Ensure the open side of the cam-lock (marked with an arrow head on the cam) is facing toward the edge so it can mate with the cam-pin.

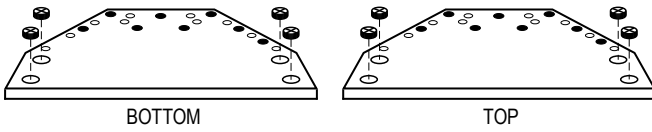

BOTTOM

TOP

Push nine wooden dowels into the top section and one into the bottom section as indicated below. Tap lightly with hammer if necessary.

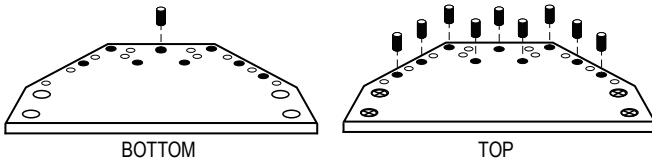

BOTTOM

TOP

With a Phillips head screwdriver, screw ten cam-pins into the small pre-drilled holes on the top section and two into the bottom section as indicated below.

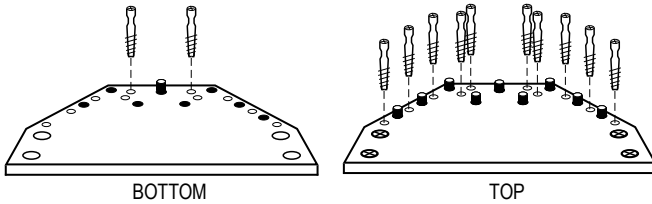

BOTTOM

TOP

- 3** Push the beveled stretchers and support blocks onto the cam-pins and dowels. Note the orientation of the small pilot holes. These need to line up so the stretcher and support block can be screwed together.

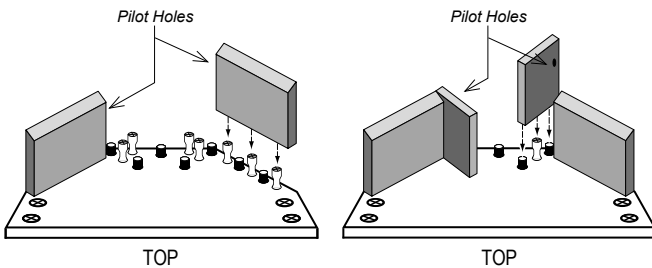

TOP

TOP

Tighten all cams snugly using a Phillips screwdriver. Drive a medium Phillips head screw through the pilot holes on each support block and beveled stretcher.

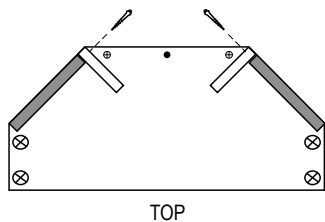

TOP

- 2** Push four cam-locks into the 48" back section. Ensure the open side of the cam-lock (marked with an arrow head on the cam) is facing toward the edge so it can mate with the cam-pin.

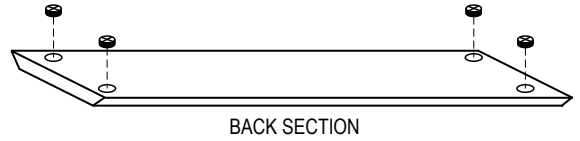

BACK SECTION

Push three cam-locks into each beveled stretcher. Note the small pilot hole drilled in the edge of each beveled stretcher. These will be used in the next step.

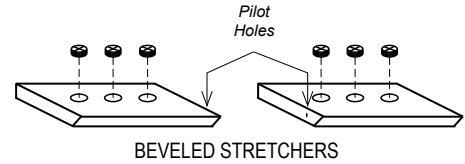

BEVELED STRETCHERS

Push one cam-lock into each support block. Note the small pilot hole on the top of each block. These will be used in the next step.

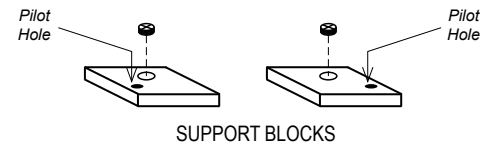

SUPPORT BLOCKS

- 4** Push two wooden dowels into each 48" side section.

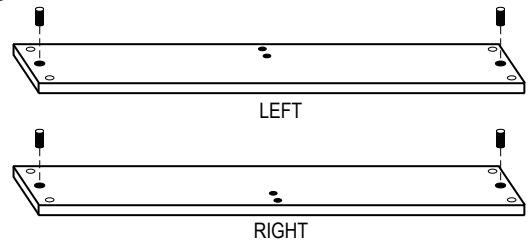

LEFT

RIGHT

Screw four cam-pins into each 48" side section.

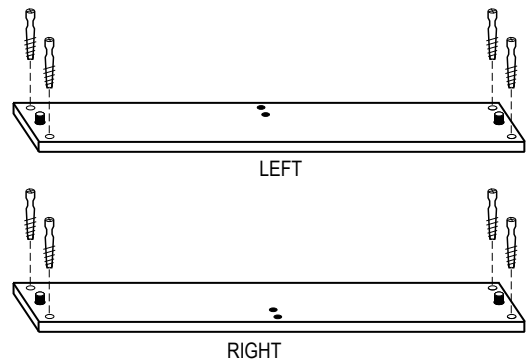

LEFT

RIGHT

- 5** Set the 48" back section onto the top assembly being careful to line up the cam-pins and dowels. Tighten all cams snugly using a Phillips screwdriver. Set the bottom section onto the back section and tighten the cams.

Rotate the frame so it is up-side-right.

Attach the 48" sides being careful to line up the cam-pins and dowels. Tighten the cams.

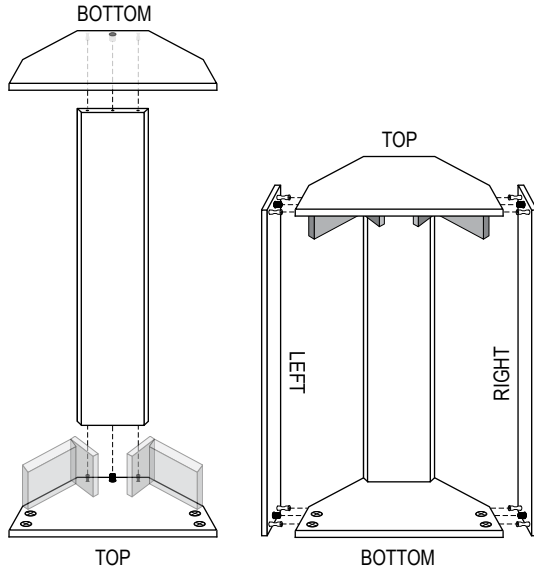

- 6** Set the two panel stops on their edge with the four small pilot holes facing up. Lay the vinyl material on top of the panel stops.

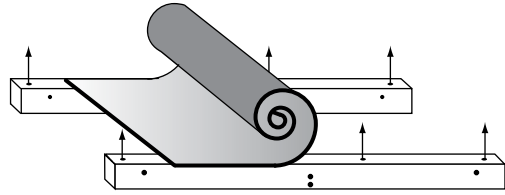

Line up the edges flush and square. Drive eight short Phillips pan-head screws through the vinyl into the small pilot holes. Avoid stretching the vinyl between screws. It should lay flat and limp.

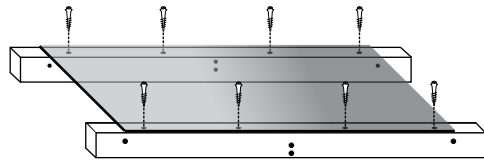

- 7** Set the vinyl barrier and panel stop assembly into the frame. Attach the panel stops using eight medium Phillips screws into the pre-drilled hole locations on the inside of the 48" side sections.

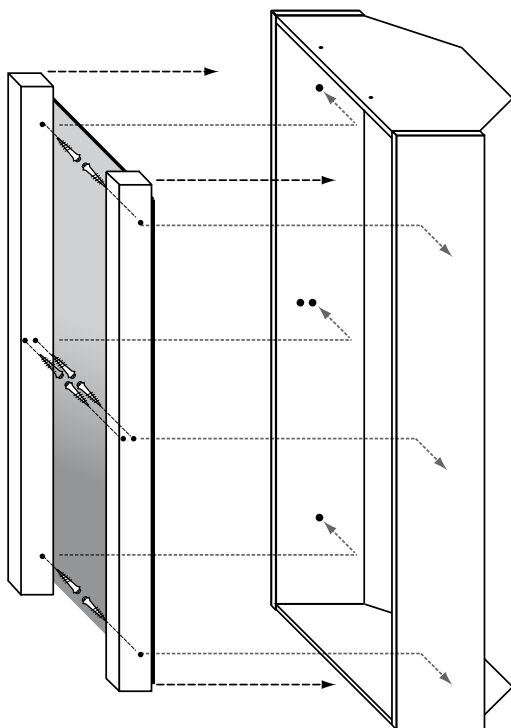

- 8** Push the Broadway acoustic panel into the front of the frame assembly. The panel should fit snugly inside the frame. Do not force the panel into place.

Fasten the Broadway panel with two Phillips pan-head screws through the pre-drilled holes in the top section. This will prevent accidental dislodgment of the panel.

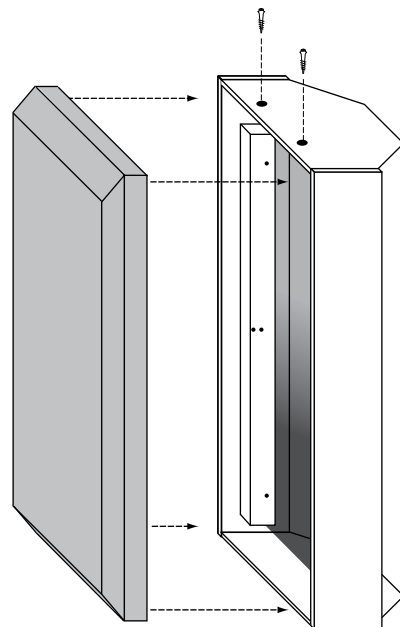

WALL MOUNTING INSTRUCTIONS

Select the corner where you would like to hang your MaxTrap. Ideally, the center of the MaxTrap should be placed at the same height as your ears when seated in your listening position but this is flexible if room décor or listening position dictates otherwise.

1 Use a bubble level and pencil to make two horizontal lines out from the corner where you want the top of the MaxTrap to be.

2 Measure out from the corner 8.5 inches and mark a vertical line. This line represents the edge of the beveled wall cleat that will be closest to the corner.

3 From the top line measure down 3.75 inches and mark a short horizontal line. This line represents the top of the beveled wall cleat.

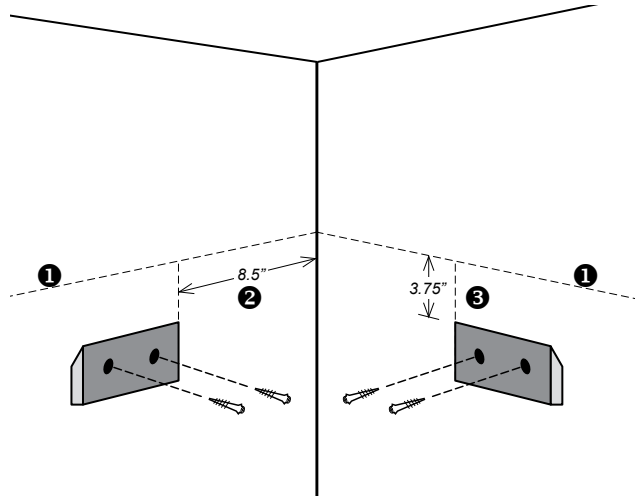

4 Pre-drill two 1/8" holes in each beveled wall cleat. Drive two heavy duty Phillips screw into each wall cleat so the tips of the screws slightly protrude. This will help to mark the plastic anchor locations in the next step.

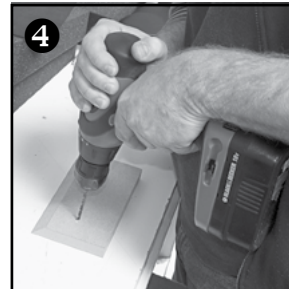

5 Line the beveled wall cleats up with the lines you marked on the wall in steps 2 and 3. Press the screw tips into the wall to mark the positions for the plastic drywall anchors.

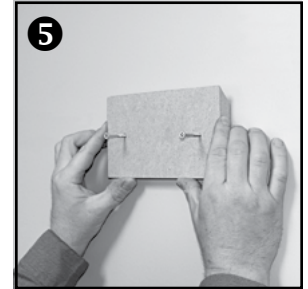

6 Push the four plastic anchors into the wall where you marked in step 5. Tap lightly with a hammer to drive the anchor in and screw the plastic anchor flush to the wall.

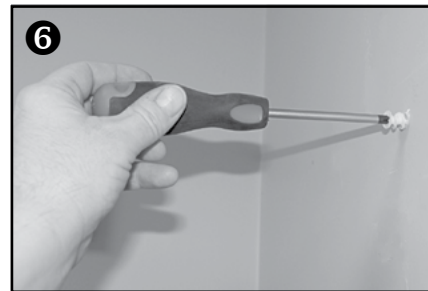

7 Screw the beveled wall cleats into the plastic anchors. Ensure the beveled edge is on top and facing the wall as shown in the diagram.

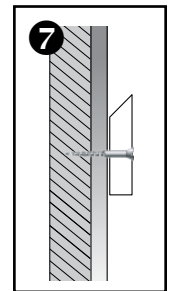

8 With the help of a second person, lift the completed MaxTrap assembly up and gently rest the back of the Maxtrap down onto the beveled wall cleats. The beveled edges on the stretchers and cleats will lock together and safely support the MaxTrap.

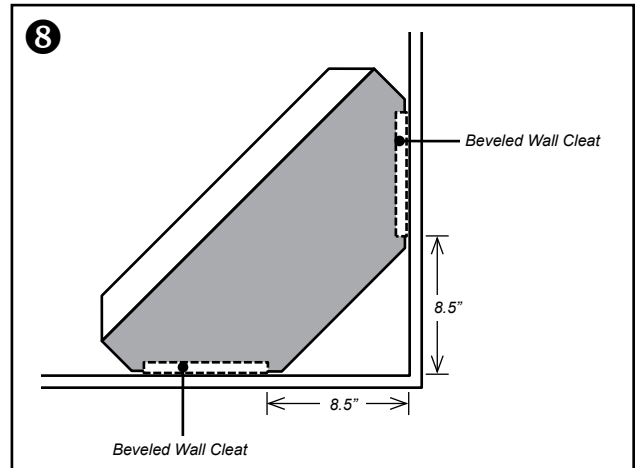

! WARNING: The installation methods outlined are recommendations only. Please seek professional advice if you are unsure about any of these methods.